



# KYB

Our Precision, Your Advantage

# 2016-2017



永華機械工業股份有限公司

KYB Manufacturing Taiwan Co.,Ltd.

33450 桃園市八德區廣興路 493 號

No.493, Guangxing Rd., Bade Dist.,

Taoyuan City 33450, Taiwan (R.O.C.)

Tel : +886-3-368-3123 Fax : +886-3-368-3369

[yunghwa.com.tw](http://yunghwa.com.tw)

台灣總代理 永琴實業股份有限公司

YC & Bruder Co.,Ltd.

100 台北市青島東路 9 號 6 樓之 1

6F.-1, No.9, Ching Dao E. Rd., Zhongzheng Dist.,

Taipei City 100, Taiwan (R.O.C.)

Tel : +886-2-2394-3606 Fax : +886-2-2394-3736

[ycb.com.tw](http://ycb.com.tw)

本型錄使用環保紙張製作

Printed in TaiWan

## Shock Absorbers Strut Assemblies

## 汽車避震器 汽車總成件

SHOCK ABSORBERS 2016-2017



台灣總代理 永琴實業  
YC & Bruder Co.,Ltd.

# 當更換避震器之後... When Shock Absorbers Are Replaced...

## When Shock Absorbers Are Worn... / 當避震器老舊時



### Vibration

When accelerating and braking, the car's body bounces up and down, causing an unstable ride.

### 起步不穩

起步或煞車時車身上下劇烈顛簸，乘坐者感覺不穩。

### Difficulty Turning

When taking a corner, the shock absorber's compression speed is too high, making it harder to return.

### 轉彎失靈

轉彎時傾斜速度較快，方向盤會有失靈傾向。

### Difficulty Stopping

When stopping, the car nose dives, and the distance required to stop increases.

### 煞車不靈

煞車制動時向前衝勢較猛，制動距離較長。

### More Comfort

Road shock and small vibrations decrease, and the car remains flat for a smooth, comfortable ride.

### 更舒適

上下顛簸感，細小震動減少，使乘坐更加平穩舒適。

### More Stability

Roll is more controlled, nose dive and acceleration squat are reduced.

### 更穩定

車體的搖擺得到抑制，剎車時的前衝感以及起步時的聳動感減少。

### More Safety

Stability and controllability show remarkable improvement when going straight or taking a corner, and braking distance decreases.

### 更放心

直行、轉彎的操縱穩定性顯著提高，制動距離亦得以控制。

## Replacement Checklist >>>

1. Distance traveled is over 50,000 km.
2. Tire treadwear indication
3. A seeming abnormality in shock absorbers: a leak in the oil seal, a noticeable dent in the outer shell, deterioration or damage to the rubber on the mounting bush

## 更換時的檢查要領 >>>

1. 行駛距離超過五萬公里
2. 輪胎有打滑徵兆
3. 避震器外觀發現異常變化：油封處有滲漏現象、外殼有顯著凹陷、底座部分的軸襯、橡膠老化或破損。

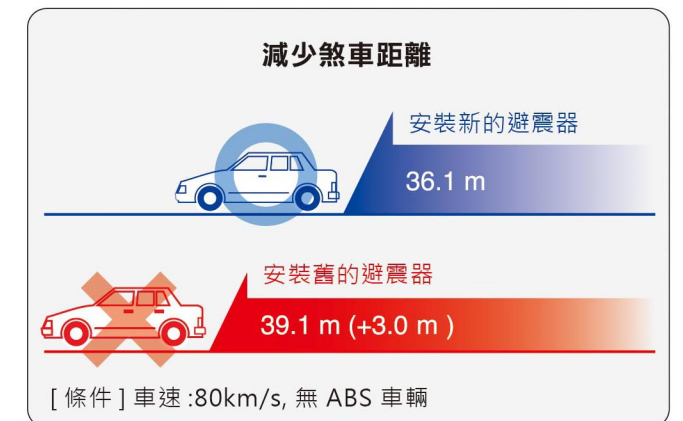
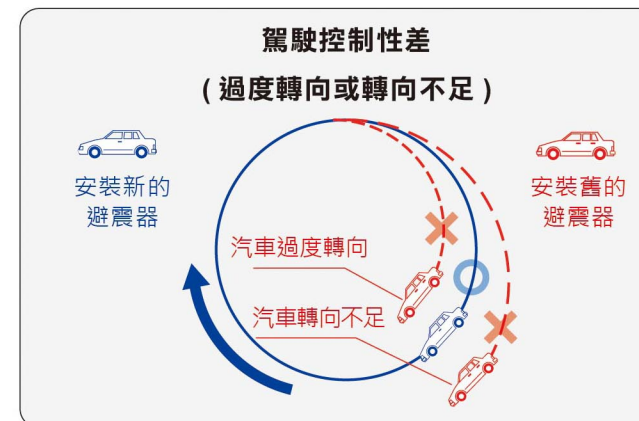

# KYB 的避震器介紹... KYB's Shock Absorbers Are...

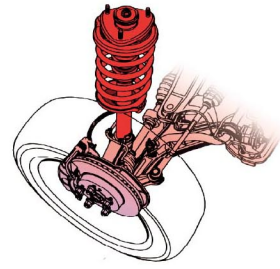

## Quality and Control

One out of every two cars in Japan and one out of every five cars in the world is equipped with KYB shock absorbers. To live up to such consumer confidence, KYB designs products that improve driving stability from the streets to the highway in order to provide the driver with handling and control. Representative of this are Premium, Excel-G and Gas-A-Just.

## 輕柔且有力

在日本每兩台汽車中就有一台、世界上每五台汽車中就有一台搭載有 KYB 的避震器。為了不辜負如此的厚愛，KYB 為消費者準備了提高汽車行駛穩定性的產品，無論是一般道路還是高速公路，都能使您體驗到頂級的平穩駕感。其中最具代表性的就是 Excel-G、Premium 和 Gas-A-Just。

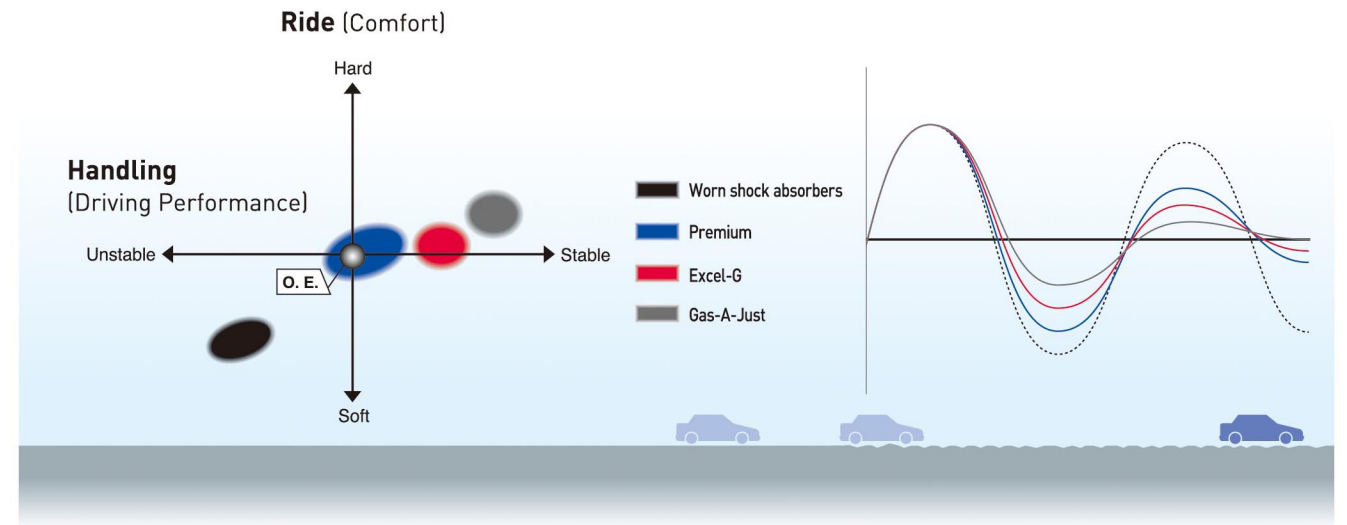

34 Series Gas Filled Twin Tube Type  
33 Series Gas Filled Twin Tube MacPherson Strut Type  
36 Series Gas Filled Strut Cartridge Type

### For a Quality Ride — **Excel-G** 高質量的行駛

- Adopts a low pressure gas filled type twin tube construction
- Corresponds with the suspension geometry of all car models, from the struts to the multilink
- Achieves a high dimensional combination of quality ride, stability, and controllability while placing emphasis on retaining a car's individual feel
- Uses multilip oil valves, high quality oil, three stage valves, and ensures a high performance standard

- 採用了低壓氣體注入式雙筒構造
- 適用於所有車型的從壓杆到支柱式避震器各種懸架形狀
- 在重視獨創品味的同時，從更高層面實現了乘坐舒適感和操縱穩定性的共存
- 採用多唇油封、優質油、三段閥，以確保優良的基本性能和耐久性。



44 (13) Series Shock Absorber (Except 136 series)  
63 Series MacPherson Strut Type  
66 Series Strut Cartridge Type

### For a Stable Ride — **Premium** 穩定的行駛

- Adopts a twin tube construction
- Ensures superb durability with high precision cylinder and high quality oil

- 採用雙筒結構
- 採用高精度氣缸和優質油，確保高耐久性



55 Series Gas Filled Mono Tube Type

### For a High Performance Ride — **Gas-A-Just** 高性能的行駛

- Adopts a high pressure gas filled type monotube construction
- Exercises high speed performance for use in long distance driving
- Ensures superb durability with high precision cylinder and high quality oil

- 採用高壓氣體注入式單筒構造
- 在遠距離高速行駛中發揮性能
- 採用高精度氣缸和優質油，確保優良的耐久性

# 避震器詳細解析... About Shock Absorbers...

There are 2 basic designs used for shock absorbers:  
twin tube type and mono tube type.

避震器一般可分為雙筒式和單筒式兩種

## 1. Twin Tube Shock Absorbers

In the twin tube type structure of the outer seal and the interior of the cylinder, oil is injected into the interior of the cylinder and the reservoir. The remainder is filled with only air (oil type standard shock absorber) or only nitrogen gas (twin tube gas shock absorber) (low pressure type with filler gas pressure of 10 kg/cm<sup>2</sup> or less).

- The valve which provides damping force is made of two parts, which makes precision tuning easy.

由外殼與內部汽缸組成的雙重構造，油被注入至汽缸內部和油箱中。其餘的僅注入空氣（油壓式標準避震器）或氮氣（雙筒式氣壓避震器）（注入氣壓為 10kg/cm<sup>2</sup> 以下的低壓型）。

- 阻尼力發生閥有兩處，因此較易進行精密微調。

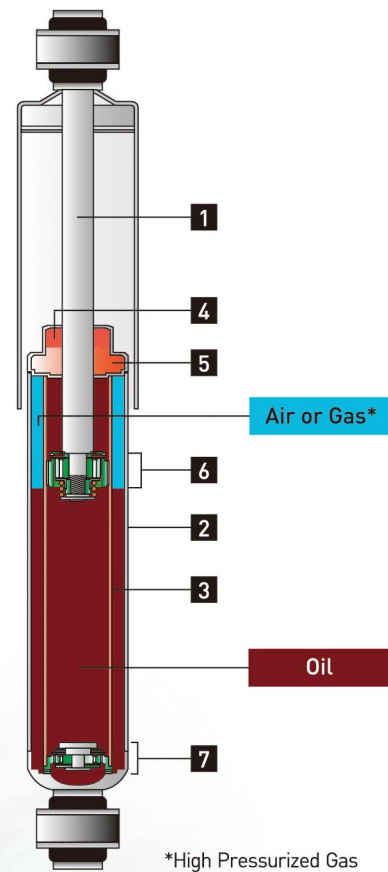

- 1 >>> Piston Rod
- 2 >>> Outer
- 3 >>> Cylinder
- 4 >>> Seal (Oil Seal)
- 5 >>> Rod Guide
- 6 >>> Piston Valve Unit
- 7 >>> Base Valve Unit

## 2. Mono Tube Shock Absorbers

In the cylinder section of a mono tube type structure, the interior of the tube is divided into the oil chamber and the gas chamber by an oil-filled free piston. The remainder is nitrogen gas (high pressure type with filler gas pressure of 15 kg/cm<sup>2</sup> to 30 kg/cm<sup>2</sup>).

- As gas pressure is high, the damping force retains stability.

為僅有汽缸的單筒構造，筒內注滿油，被自由活塞分為油艙與氣艙。其餘的注入氮氣（注入氣壓為 15kg/cm<sup>2</sup>~ 30kg/cm<sup>2</sup> 的高壓型）。

- 因經常保持高氣壓，阻尼力較穩定。

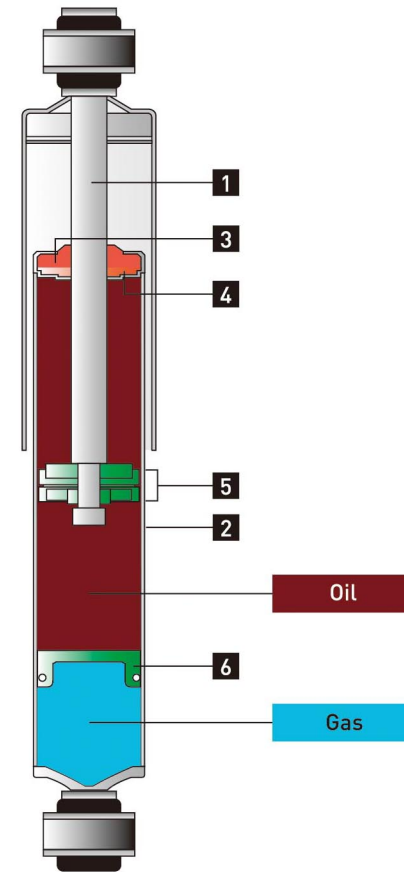

- 1 >>> Piston Rod
- 2 >>> Outer
- 3 >>> Seal (Oil Seal)
- 4 >>> Rubber Cushion
- 5 >>> Piston Valve Unit
- 6 >>> Floating Diving Piston

# 避震器詳細解析... About Shock Absorbers...

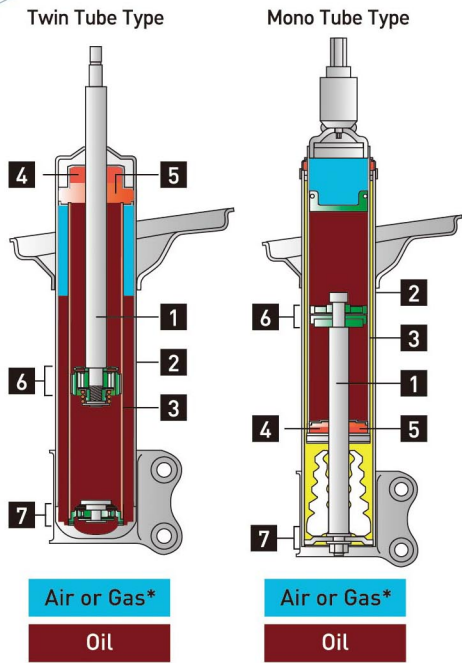

## 3. MacPherson Strut

As a component of the suspension, the strut controls the function of positioning a car's wheel.

懸架構件的一部分，是決定車輪位置的結構性部件，故此確保了其高強度。

- 1 >>> Piston Rod
- 2 >>> Outer
- 3 >>> Cylinder
- 4 >>> Seal (Oil Seal)
- 5 >>> Rod Guide
- 6 >>> Piston Valve Unit
- 7 >>> Base Valve Unit

\*High Pressurized Gas

## 4. MacPherson Strut Cartridge

This is a replacement part for the functional portion of the strut which provides damping force.

僅用於更換壓桿中阻尼力發生的功能性部分。

- 1 >>> Piston Rod
- 2 >>> Outer
- 3 >>> Cylinder
- 4 >>> Seal (Oil Seal)
- 5 >>> Rod Guide
- 6 >>> Piston Valve Unit
- 7 >>> Base Valve Unit

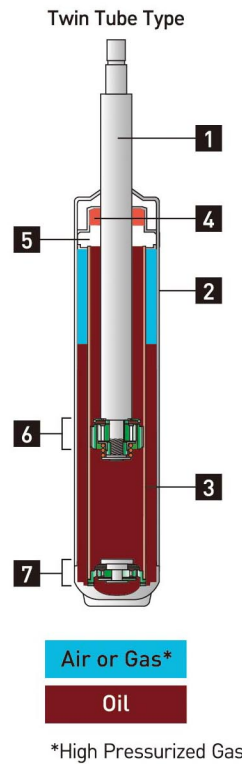

\*High Pressurized Gas

## Steering Damper "KS" Series

This damper controls sudden steering wheel movements based on adjustments to road conditions.

用於抑制路面原因引起的方向盤劇烈抖動的阻尼器。

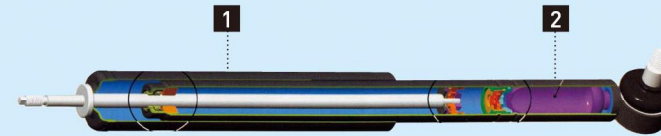
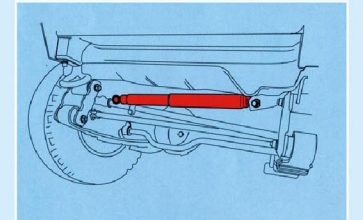

- 1 >>> Protective Shell
- 2 >>> Specially Designed Air Chamber

## Stay Damper (Gas Spring) "110000" Series

Gas springs are used to open and close the rear doors of hatchbacks and recreational vehicles.

用於掀背式轎車或RV車的后門開關的 Gas Spring。

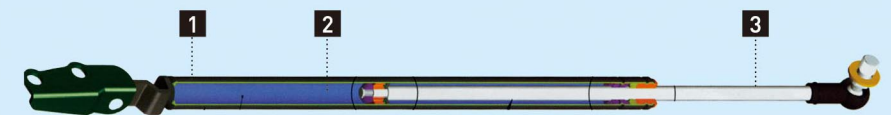
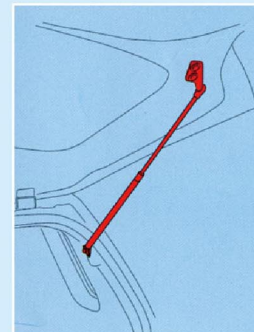

- 1 >>> Crack Free Chromed Piston Rod
- 2 >>> High Pressure Nitrogen Gas & Oil
- 3 >>> Seamless Cylinder

KYB 團隊 避震器生產工廠 ...  
 KYB Group's Shock Absorber Manufacturing Plants ...

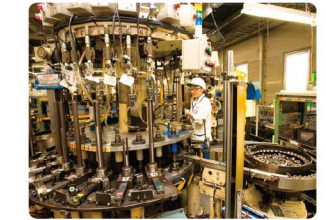

Since our inception in 1935, KYB has persistently pushed to offer ever better products to our customers as a company which practices *Monozukuri* (manufacturing expertise). In the future, we plan to continue producing technologies aimed at customer satisfaction with our colleagues all over the world.

自 1935 年開展業務以來，秉持為客戶提供更好的產品為原則，始終致力於打造優質產品的公司形象。

今後，我們仍然將繼續發揮 KYB 的技術優勢，為全世界的同行與客戶們提供更好的服務。



KYB Developmental Experiment Center  
 Test course



Gifu North Plant



KYB 全球各分部據點地圖...

Global Network for Aftermarket Shock Absorber Sales...

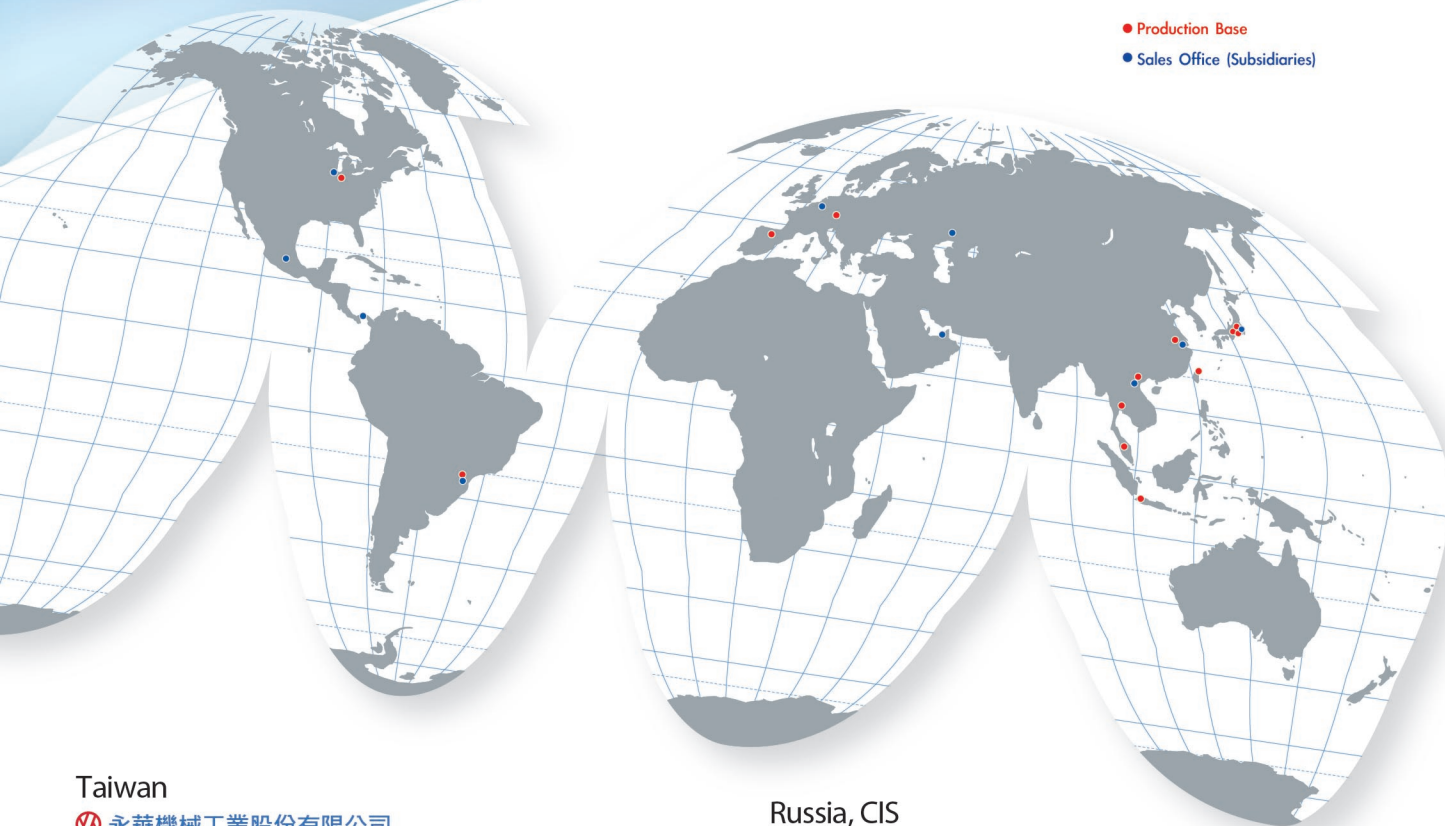

Taiwan

永華機械工業股份有限公司  
KYB Manufacturing Taiwan Co.,Ltd.  
33450 桃園市八德區廣興路 493 號  
No.493, Guangxing Rd., Bade Dist.,  
Taoyuan City 33450, Taiwan (R.O.C.)  
Tel : +886-3-368-3123 Fax : +886-3-368-3369  
yunghwa.com.tw

Europe

KYB Europe GmbH  
Kimplerstrasse 336, 47807 Krefeld, Germany  
Tel : +49-2151-931430 Fax : +49-2151-9314320  
kyb-europe.com

Middle East & Africa

KYB Middle East FZE  
LOB16-304 Jebel Ali Free Zone,  
Dubai, UAE, P.O. BOX 261819  
Tel : +971-4-887-2448 Fax : +971-4-887-2438  
kybmiddleeast.com

Mexico

KYB Latinoamerica, S.A. de C.V.  
Av. de Las Palmas No.731, Despacho 1301, Piso 14,  
Col. Lomas de Chapultepec, Mexico D.F. C.P. 11000  
Tel : +52-55-5282-5770 Fax : +52-55-5282-5661  
kybmx.com

Asia (except China, Hong Kong, Macao) & Oceania

KYB Asia Co., Ltd.  
105/1-2 Moo 1, Bangna-Trad Road KM. 21,  
Srisajorakaeyai, Bangsaonthong  
Samutprakarn, 10540, Thailand  
Tel : +66-2740-0801/0802/0803/0804 Fax : +66-2740-0805  
kyba.co.th

Russia, CIS

LLC KYB Eurasia  
56 Profsoyuznaya Street,  
Moscow, 117393, Russian Federation  
Tel : +7-495-7818852 Fax : +7-495-7818852 ext.512  
kyb.ru

North America

KYB Americas Corporation  
2625 North Morton, Franklin, Indiana 46131, USA  
Tel : +1-317-736-7774 Fax : +1-317-736-4618  
kyb.com

Latin America

KYB Panamá S.A.  
P.H. WORLD TRADE CENTER Piso 17, Oficina 1705,  
Marbella, Ciudad de Panamá, República de Panamá  
P.O. Box 0832-00759  
Tel : +507-213-8300 / 8301  
kyb.com.pa

China, Hong Kong, Macao & Mongolia

KYB Trading (Shanghai) Co., Ltd.  
B1008-1009 Far East International Plaza, 317 Xianxia Road,  
Shanghai 200051, China  
Tel : +86-21-6211-9299 Fax : +86-21-5237-9001  
kybcn.com

Brazil

Comercial de Autopeças KYB do Brasil LTDA  
Rua Cyro Correia Pereira, 2400 - sala 07.  
Cidade Industrial Curitiba, Parana, Brasil  
Zip : 81.460-050  
Tel : +55-41-3012-3620 Fax : +55-41-3012-3620  
kyb.com.br

SHOCK ABSORBER LISTINGS BY MAKE & MODEL

汽車避震器 (按製造商和車款索引)

ASIA ( KO )	15
DAEWOO ( KO )	15
DAIHATSU ( J )	15
HINO ( J )	17
HONDA ( J )	17
HYUNDAI ( KO )	20
ISUZU ( J )	22
KIA ( KO )	23
MAZDA ( J )	25
MITSUBISHI ( J )	28
NISSAN ( J )	33
PROTON ( MA )	38
SAMSUNG ( KO )	39
SSABGYONG ( KO )	39
SUBARU ( J )	39
SUZUKI ( J )	41
LEXUS ( J )	42
TOYOTA ( J )	43
AUDI	53
BMW	55
CITROEN	59
CITROEN COMMERCIAL	59
MERCEDES BENZ	59
MINI	60
OPEL	60
PEUGEOT	60
SAAB	61
SKODA	61
SMART	62
VOLKSWAGEN	63
VOLVO	68

CABIN DAMPER "130000" SERIES LISTINGS BY MAKE & OEM No. ----- 69

"130000" 系列大車件號 (按製造商和 OEM 號碼索引)

**SHOCK ABSORBER LISTINGS BY MAKE & MODEL**
**汽車避震器 (按製造商和車款索引)**

<b>ASIA</b>	TIBURON -----20	METRO -----25	AVENIR -----34	JUSTY, J Series -----40	FUN CARGO -----52
ROKSTA -----15	TRAJET XG -----21	MPV -----27	BLUEBIRD -----34,35	LEGACY -----40	HARRIER -----48
<b>DAEWOO</b>	TUCSON -----21	MX-6 -----26	BLUEBIRD SYLPHY -----33	LIBERTY -----40	HI ACE -----48
ARANOS -----15	VERACRUZ -----21	PREMACY -----27	BLUEBIRD WAGON -----34,35		HI LUX -----49
CHEVROLET AVEO -----15	VG -----21	PROCEED -----26	BUS -----34	<b>SUZUKI</b>	HI LUX FORTUNER -----49
CHEVROLET MATIZ -----15	<b>ISUZU</b>	PROTEGE -----25	CABALL -----34	AERIO -----41	HI LUX VIGO -----49
CHEVROLET SPARK -----15	BIGHORN -----22	SPECTRON -----26,27	CABSTAR -----34	BALENO -----41	HIGHLANDER -----49
ESPERO -----15	BRAVA -----22	TRIBUTE -----27	CALAVAN -----38	CHEVROLET CRUZE -----41	INNOVA -----49
KALOS -----15	BUS -----22	VERISA -----26	CEDRIC -----34	CULTUS -----42	KJIANG -----49,51
LEGANZA -----15	CAMBO -----22		CEFIRO -----35,37	CULTUS CLESENT -----41	KLUGER -----49
MATIS -----15	ELF -----22	<b>MITSUBISHI</b>	CHERRY -----37	ESCUDO -----41	LAND CRUISER -----49
MATIZ -----15	ELF150 -----23	3000GT -----29	CLIPPER -----34	EVERY -----41	LAND CRUISER PRADO -----49
NUBIRA -----15	ELF250 -----22	ADVENTURE -----28	CONDOR -----33	GEO METRO -----42	LIGHT STOUT -----51
PONTIAC G3 -----15	ELF250 WIDE -----22	AIRTREK -----28	DATSUN TRUCK (Pick-up) -----34	GRAND ESCUDO -----41	LITE ACE -----49
PONTIAC MATIZ G1 -----15	ELF350 -----22	BUS -----28	DUALIS -----36	GRAND NOMADE -----41	LUCIDA -----50
TICO -----15	FASTER -----22	CANTER -----28	DUALIS+2 -----36	GRAND VITATR -----41	MARKII -----47
<b>DAIHATSU</b>	GEMINI -----22	CARISMA (Made in Holland) -----28	ELGRAND -----34	GRAND VITARA XL-7 -----41	MODEL F -----51
BE-GO -----16	GIGA -----22	CHALLENGER -----32	FAIRLADY -----33	IGNIS -----41	OPA -----49
BOON -----16	HIGH-PACK VAN -----22	CHARIOT -----33	FUGA -----34	JIMNY -----41	PASEO -----51
CHARADE -----15	JOURNEY (LIGHT BUS) -----22	CHARIOT GRANDIS -----33	FX45 -----34	LIANA -----41	PLATZ -----52
COO -----16	LIGHT ELF -----23	CITROEN C-CROSSER -----32	GAZELLE -----36	LJ Series -----41	PREMIO -----49
CUORE -----16	MU -----23	COLT -----28,31	GLORIA -----34	RB413 -----41	PREVIA -----50
DELTA -----16	RODEO -----22,23	COLT PLUS -----28	GRAND LIVINA -----35	RITZ -----41	PRIUS -----50
DOMINO -----16	TROOPER -----22	CORDIA -----28	HOMER -----34	SAMURAI -----41	PROBOX -----50
MATERIA -----16	TRUCK -----23	DEBONAIR -----22	HOMY -----38	SANTANA -----41	QUALIS -----51
MOVE -----16	WIZARD -----23	DELICA -----30	INFINITI FX35 -----34	SE416 -----41	RAUM -----50
SIRION -----16	<b>KIA</b>	DIAMANTE -----32	INFINITI G20 -----35	SIERRA -----41	RAV-4 -----50
STORIA -----16	BESTA -----23	DION -----28	INFINITI G35 -----35	SJ41# -----41	RUSH -----50
TAFT -----16	CARENS -----23	DODGE AVENGER -----29	INFINITI I30 -----35	SOLIO -----41	SCEPTER -----52
TERIOS -----16	CARNIVAL -----23	DOGE STEALTH -----29	INFINITI M35 -----34	SPLASH -----41	SIENNA -----50,51
<b>HINO</b>	CARSTAR -----23	EAGLE TALON -----29	INFINITI M45 -----34	SQ416 -----41	SOARER -----51
BUS -----17	CLARUS -----24	ECLIPSE -----29	INFINITI QX4 -----37	SQ420 -----41	SOLUNA VIOS -----52
RANGER TRUCK -----17	CREDOS I II -----24	EXPO -----33	JUNIOR -----35	SQ425 -----41	SPACE CRUISER -----51
TRUCK -----17	JOICE -----23	FORTE -----29	LIVINA GENISS -----35	SR410 -----41	SPACIO -----46
<b>HONDA</b>	LEO -----24	FTO -----29	MARCH -----35	SR412 -----41	SPRINTER -----46
ACCORD -----17,18	LOTZE -----24	GALANT -----29	MAXIMA -----35,37	SUPER CARRY -----41	SPRINTER CARIB -----46
CITY -----18	MAGENTIS -----24	GARNDIS -----29	MICRA -----35	SV420 -----41	STARLET -----51
CIVIC -----18	MENTOR -----24	GTO -----29	MILER -----35	SV620 -----41	STOUT -----51
CONCERTO -----18	OPTIMA -----24	JEEP -----29	MISTRAL -----37	SWIFT -----42	SUCCEED -----50
CR-V -----19	PICANTO -----24	JUPITER -----29	MURANO -----35	VITARA -----41	SUPRA -----45,51
CR-X -----19	PREGIO -----24	L200 -----29	PATHFINDER -----37	WAGON R -----41	T.U.V. (CONDOR/KIJANG/QUALIS/REVO/TAMARAWFX/ZACE) -----51
FIT -----19	PRIDE -----24	L300 -----30	PRESEA -----35	WAGON R PLUS -----41	TACOMA -----51
INTEGRA -----19	RIO -----24	L400 -----30	PRESIDENT -----35	WAGON R SOLIO -----41	TAMARAW -----51
JAZZ -----19	RIO RX-V -----24	LAMBDA -----29	PRIMERA WAGON -----34,35	X-90 -----41	TARAGO -----50
LEGEND -----19	SEDONA -----23	LANCER -----28,30,31	PULSAR -----37	<b>LEXUS</b>	TERCEL -----51
LOGO -----19	SEPHIA I -----24	LANCER CEDIA -----31	QASHQAI -----36	ES -----42	TOWN ACE -----51
ODYSSEY -----19	SEPHIA II -----24	LANCER ESTATE -----30	QASHQAI+2 -----36	GS -----42	TOYO ACE -----51
PRELUDE -----19	SHUMA -----24	LANCER FIORE -----28	QUEST -----36	IS -----42	VIENTA -----52
SHUTTLE -----19	SHUMA II -----24	LEGNUM -----29	ROGUE -----36	LS -----43	VIOS -----52
STREAM -----19	SORENTO -----24	LIBERO -----30	SERENA -----38	RX -----43	VISTA -----44,52
VIGOR -----18	SPECTRA -----24	MAGNA -----29,32	SILVIA -----36	SC -----43	VISTA ARDEO -----52
<b>HYUNDAI</b>	SPORTAGE -----24	MIRAGE -----28,31	SKYLINE -----36	<b>TOYOTA</b>	VITZ -----52
ACCENT -----20,21	<b>MAZDA</b>	MONTERO -----32	STANZA -----38	4-RUNNER -----43	WINDOM -----52
ATOS -----20	121 -----25	MONTERO SPORT -----32	SUNNY -----36,37	ALLION -----49	WISH -----52
ATOZ -----20	323 -----25	NATIVA -----32	SUNNY TRAVELLER -----36	ALPHARD -----43	YARIS -----52
AVANTE -----21	323F -----25	NIMBUS -----29,33	TEANA -----37	ALTEZZA -----43	YARIS VERSO -----52
AVANTE XD -----20	323S -----25	OUTLANDER -----28,32	TERRANO -----37	ARISTO -----44	ZACE -----51
CLICK -----20	616(CAPELLA) -----26	PAJERO -----32	TERRANOII -----37	AURION -----44	<b>歐洲車系</b>
COUPE -----20	626 MILLENIUM -----26	PAJERO SPORT -----32	TIIDA -----37	AVALON -----52	AUDI -----53,54,55
EF SONATA -----20	626 NEW MILLENIUM -----26	PEUGEOT 4007 -----32	TIIDA LATIO -----37	AVANZA -----44	BMW -----55,56,57,58,59
ELANTRA -----20,21	626(CAPELLA) -----26	ROSA -----32	TRUCK -----38	AVENSIS -----47	CITROEN -----59
EON -----20	ASAHI -----26	SANTAMO -----32	URVAN -----38	BELTA -----52	CITROEN COMMERCIAL -----59
EXCEL -----20	ASTINA -----25	SAPPORO -----29	VANETTE SERENA -----38	CALDINA -----44	MERCEDES BENZ -----59
GALLOPER -----20	ATENZA -----27	SHOGUN -----32	VERSA -----37	CAMRY -----44,52	MINI -----60
GETZ -----20	AXELA -----27	SIGMA -----29,32	VIOLET -----38	CAMRY GRACIA -----44	OPEL -----60
GRACE -----20	B Series -----26	SPACE GEAR -----30	WINGROAD -----33	CARINA -----44	PEUGEOT -----60,61
GRANDEUR -----20	BONGO -----26,27	SPACE RUNNER (RVR) -----32	X-TRAIL -----38	CARINA II -----47	SAAB -----61
GRANDEUR XG -----20	DEMIO -----25,26	SPACE STAR -----33	<b>PROTON</b>	CARINA E -----47	SKODA -----61,62
GRANDEUR XG25 -----20	E Series -----26	SPACE WAGON -----29,33	300 -----38	CHASER -----47	SMART -----62
GRANDEUR XG30 -----20	E2000, E2200 -----27	SPACE WAGON (VAN) -----33	400 -----38	COASTER -----45	VOLKSWAGEN -----63,64,65,66,67
H1 STAREX -----21	FAMILIA -----25	STARION -----33	COUPE -----38	COROLLA -----45,46	VOLVO -----68
H100 -----21	FESTIVA -----25	STRADA -----29	PERSONA -----38	COROLLA ALTIS (ASIA/INDIA) -----46	
ix55 -----21	FESTIVA WAGON -----25	TREDIA -----28	SATRIA -----38	COROLLA AXIO -----46	
JM -----21	FORD ESCAPE -----27	TRITON -----29	WIRA -----38	COROLLA FIELDER -----46	
LANTRA -----21	FORD FIESTA -----26	TRUCK -----33	<b>SAMSUNG</b>	COROLLA SEDAN -----46	
MARCIA -----21	FORD J80 -----26,27	VERADA -----32	520 -----39	COROLLA WAGON -----46	
MATRIX -----21	FORD LASER -----25	<b>NISSAN</b>	400 -----38	CORONA -----47	
PONY EXCEL -----21	FORD MAVERICK -----27	100NX -----37	COUPE -----38	CORSA -----51	
PORTER -----21	FORD TELSTAR -----26	280C -----34	PERSONA -----38	CRESSIDA -----47	
SANTA FE -----21	FORD TELSTAR, PROBE -----26	350ZX -----33	SATRIA -----38	CRESTA -----47	
SANTAMO -----21	LANTIS -----25	720 -----34	WIRA -----38	CROWN -----47	
SONATA I -----21	LIATA -----25	810 -----35	<b>SSABGYONG</b>	DYNA -----48	
SONATA II, III -----21	MAZDA 2 -----26	AD RESORT -----33,36	MUSSO -----39	DYNA 150 -----48	
TB -----20	MAZDA 3 -----27	AD VAN -----33,36	<b>SUBARU</b>	ECHO -----52	
TERRACAN -----21	MAZDA 5 -----27	AD WAGON -----33,36	FORESTER -----39	EMINA -----50	
	MAZDA 6 -----27	ALMERA -----36	IMPREZA -----39,40	ESTIMA -----50	
	MAZDA 8 -----27	ALTIMA -----33,34	IMPREZA WRX -----40		

ASIA

製造商	車款	年份	規格	R	前		後	
					KYB No.		KYB No.	
					OIL	GAS	OIL	GAS
ASIA	ROKSTA					554106		

DAEWOO

製造商	車款	年份	規格	R	前		後	
					KYB No.		KYB No.	
					OIL	GAS	OIL	GAS
DAEWOO	ESPERO/ARANOS	92~	1.5L, 1.8L, 2.0L			365025		553075
	KALOS/CHEVROLET AVEO/PONTIAC G3							
		02/09~	1.2i, 1.4i for Europe	R				343423
				L				
		04~09	LS, LT 1.6L all to VIN 373623 for USA	R				343423
				L				
		09~11	LS, LT 1.6L all from VIN 373623 for USA	R				343423
				L				
	LEGANZA							
		97~	Chassis No.KLAV****(E)	R		334211		334213
				L		334212		334214
	MATIZ/Chevrolet MATIZ/Chevrolet SPARK/PONTIAC MATIZ G1							
		02~	for Mexico	R		332130	443301	343304
				L		332131		
	MATIZ/MATIS							
		98~	ALL Chassis No.KLY4A****	R		332100		
				L		332101		
	NUBIRA							
		97~97/07	Chassis No.KLAJ****(E)V	R		334207		333254
				L		334208		333255
		97/08~	Chassis No.KLAJ****(E)W/(E)X/(E)Y	R		334209		333254
				L		334210		333255
	TICO							
		96~	ALL VIN No.KLY3S1*	R				342020
				L				

DAIHATSU

製造商	車款	年份	規格	R	前		後	
					KYB No.		KYB No.	
					OIL	GAS	OIL	GAS
DAIHATSU	CHARADE							
		87/01~93/02	G100 except Turbo, GT-it G101 incl. Turbo G102 except Sedan, R-Grade Package	R		332043		
				L		332044		
		87/01~93/02	G100 GT-ti	R		332043		332045
				L		332044		332046
		87/01~93/02	G100 Turbo except GT-ti G102 with R-Grade Package	R		332043		
				L		332044		
		89/03~93/02	G102 Sedan	R		332043		
				L		332044		
		96/06~	G200,G202,G203	R		333244		333246
				L		333245		333247

製造商	車款	年份	規格	R	前		後	
					KYB No.		KYB No.	
					OIL	GAS	OIL	GAS
	CUORE/DOMINO/MOVE							
		98/10~	L901	R				342022
				L				
	DELTA							
		64~70	SV20, 22, 24			444025	344063	
		64~70	SV22, 24(T), SV20, 22, 24			444025		
		70/10~77/08	DV20, 22, 24, 32(L)			444025		
		70/10~77/08	DV21, 23, 26(M) (TRUCK MIXER)					444025 344063
		77/08~84/09	V10T, V57, 78, 98			444064		444061
		77/08~84/09	V76, 79, 99			444064		
		84/09~	V57, 98(Low Deck, Low Deck Dump)			444064		
		84/09~	V75			444064		
		84/09~	V75, 79, 99(Special Chassis, Low Deck)			444064		
	MATERIA/COO							
		06/10~	ALL	R				343406
				L				
	SIRION/STORIA							
		98/01~00	M100(1.0, 2WD) chassis No.→M100 - 538945	R		332104		
				L		332105		
		98/01~00	M100(1.0, 2WD) chassis No.→M100 - 538945	R		332104		
				L		332105		
		00~	M100(1.0, 2WD) chassis No.M100 - 538946→M101 (1.3, 2WD)	R		332110		
				L		332111		
		98/04~00	M110(1.0, 4WD) chassis No.→M110 - 542039	R		332104		
				L		332105		342023
		00~	M110(1.0, 4WD) chassis No.M110 - 542040→M111(1.3, 4WD)	R		332110		
				L		332111		342023
	SIRION/STORIA/BOON							
		04/05~	M300/M301(2WD) 1.0, 1.3, 1.3S				332120	
		04/05~	M310(4WD) 1.0, 1.3, 1.3S				332120	
	TAFT							
		74/08~78/07	F10, 20Series				343213	
		74/08~84/03	F20V, 50V					553143
		82/10~84	F60					553143
	TERIOS							
		97/03~	J100(2WD) incl. With ABS	R				342024
				L				
		98/09~	ALL	R				343483
				L				
	TERIOS/BE-GO							
		06/01~08/11	J200/210/211				333496	

HINO

製造商	車款	年份	規格	前		後			
				R	KYB No.		L	KYB No.	
					OIL	GAS		OIL	GAS
HINO	BUS								
		62~77/07	RE-PSeries(AIR SUS.), RVSeries(HIGH SPEED TOURING BUS)		445046				
		62~77/07	RESeries(LEAF SPRING), RDSeries		446056		447001		
		62~77/07	BW320RAINBOW (LIGHT-BUS) (Middle Size)		444060		445044		
		66~75	RLSeries, RMSeries (Middle Size)		445044		446056		
		68~78/03	RC300Series (DX.SIGHT- SEEING)		446056		447001		
		79/09~	RL300		445046				
		79/09~	RV531				446026		
		80/01~	RB				447001		
		83/12~	REP		445046				
			BX				446005		
		82/06~90	RU606BA		445050				
		87~91	RH160AA		445050				
		~88	RJ170CA		445050				
		91~	LRWIKRA, LCM, LRM		446021				
					446056				
	RANGER TRUCK								
		64~70	KMSeries, KL300Series All		444197		446056		
		71~80	KM3Series, KL3Series All				446056		
		72~79/09	KR, KUSeries All		444028				
		82/07~	FG182/183/184/185/187		444206				
		82/07~	FD174		444200				
	TRUCK								
		63~79/09	HFSeries, HESeries, HGSeries, HHSeries All(TRACTOR)		446056				
		70~75/07	KBSeries, KFSeries, ZMSeries All(Except KF, ZM300, 702Series, KB322~382)		446056				
		70~79/09	TC, TE, KSSeries All		446056				
		79~84	LB510, BX320		446010				
		~89	FD162 SA		444058				
			AK174SA		446056				
			KK				446034		
			HT2MMAA		446056				
			Y840		446056				

HONDA

製造商	車款	年份	規格	前		後			
				R	KYB No.		L	KYB No.	
					OIL	GAS		OIL	GAS
HONDA	ACCORD								
		85/06~89/12	CA1/2/3/4/5/6-1#0	R L	341072 341073		341074		
		89/09~91	CB#	R L	341117 341118		341119		
		89~96	CB#, CC#, CE#	R L	341171 341172		341173		
		91~93	CB8/9 (Wagon made in USA)	R L	341171 341172		341176		
		93/09~98	CD#, CE#	R L	341174 341175		341176		
		97/09~	CF3/4/6(1.8i/2.0i/ 2.2i Sedan/Wagon)		341255		341256		

製造商	車款	年份	規格	前		後			
				R	KYB No.		L	KYB No.	
					OIL	GAS		OIL	GAS
		98/10~	CG7/8/9, CH1(1.6i/1.8i/2.0i/ 2.2i Sedan)			341255	341256		
		98/02~	CG1/2/4/5 (2.0i/ 3.0V6 Sedan/Coupe made in USA)			341257	341258		
		03/02~	CL7/8/9, CM#			341330	341331		
		04~	2.0 VTI-L 2.0L			341381	341258		
		08~	for Mexico	R L		340040 340041	340044		
	ACCORD/VIGOR								
		03/02~	CL#(2.0L I, 2.4L I, 2.2L CDTi)			341330	341369		
		03/02~	CM1 (2.0L)/CM2(2.4L)/ CN2(2.2L CDTi)			341330			
	CITY								
		03~	Type III for Asia	R L			343381		
		03~	GD6/8 for Asia	R L			343381		
		03~	GD8/9/10 for Asia	R L			343381		
		09~	2WD for Mexico	R L			348021		
	CRV								
		83/09~87/08	AL/AM-1#0, AG/ AJ-1#0, AH/AK-1#0	R L			341050		
		84/09~87/09	AT/AU-1#0	R L			341050		
		87/07~91/08	EF1/2/3 chassis No.→1001363 EF9	R L		341135 341136			
		89/01~91/12	EC8/9, ED2/3/4/6/ 7, EE9 chassis No. S100001→	R L		341087 341088	341094		
		91/09~95/08	EG3/4/5/6/8/9,EH9	R L		341138 341139	341094		
		91/08~95/08	EG3/4/6/7/8/9	R L		341138 341139	341193		
		92/04~01	EJ1/2(Coupe)	R L		341138 341139	341094		
		95/09~00/08	EK2, EK3, EK4			341203	341198		
		95/09~00/08	EK#			341223	341224		
		01~	EU1/3/7/8, EP1/2, EM2, ES1/3 for Europe, USA	R L		331008 331009	341311		
		01~	EP3 2.0 TYPE-R	R L			341311		
		03~04	Si 3-Door 2.0L for USA	R L		331008 331009			
		03/01~	ES8 for China,Hong Kong	R L			341311		
		01~02	Sedan & Coupe	R L			341311		
		03~05	Sedan & Coupe	R L			341311		
		06/01~	All for Europe 1.4i/1/8i/2.2i-CTDi incl. Sports sus.	R L			553365		
		06~	Sedan(AT/MT)	R L		339074 339075	343479		
		05/04~	Coupe	R L			343479		
		06~	Coupe for Mexico	R L			343479		
		06/02~	All for Asia 1.8L, Vti & Vti-L, excl. 2.0L Sports Sedan	R L			343479		
		09~11	HYBRID for Mexico				343479		
	CONCERTO								
		88/06~92	MA1/2 (made in Japan)	R L		341135 341136			
		90~95	HW(made in U.K.)	R L		334068 334069	341131		

製造商	車款	年份	規格	R	前		後	
					KYB No.		KYB No.	
					OIL	GAS	OIL	GAS
CR-V		95/10~01/11	RD1(4WD)2.0-16V			341260		341261
		02~04	RD4/5/7/8/9	R		331050		341488
				L		331051		
		05~06	RD4/5/7/8/9	R				341463
				L				
			RD8 for Europe	R				341463
				L				
		07/01~	RE#	R		339261		341492
				L		339262		
		CR-X		83/10~87/08	AF100/110/120/130	R		
83/10~87/08	AS-100/110/120			R				341050
				L				
87/07~91/08	EF6/7/8			R		341135		
				L		341136		
89/01~92/03	ED9, EE8 chassis No.S100001→			R		341087		341094
				L		341088		
91/09~00	EG1/2			R		341138		341193
				L		341139		
92/04~00	EG2, EH6			R		341138		341094
		L		341139				
FIT		03/01~	GD2.4 for China	R				343381
				L				
				R		333474		
		07~	ALL for USA	R		333474		343487
				L		333475		
				R				
INTEGRA		89/04~93/04	DA5, 6, 7, 8	R		341135		
				L		341136		
				R		341138		
				L		341139		
		93/05~01/06	DB6/7/8, DC1/2	R				341193
				L				
				R				
JAZZ/FIT		01/06~	GD1/2, 1.3/1.4, 2WD(FF)	R				343381
				L				
		01~	GD#	R				343381
				L				
		02/10~	GD1/3, GLI/VTI	R				343381
				L				
09/01~	1.2/1.3/1.4 iDSi for Europe	R		338001		348016		
		L		338002				
09~	2WD for Mexico	R				348021		
		L						
LEGEND		86~88	HS	R		341112		
				L		341113		
		89~90	KA3/4	R		341112		341116
				L		341113		
		03~	KA9	R		341434		341437
				L		341435		
LOGO		99/03~	GA3/5	R		332106		343318
				L		332107		
ODYSSEY/SHUTTLE		94/09~99	RA1/2/3/4/5	R		341200		344274
				L		341201		
		99/12~03	RA6/7/8/9	R				344274
				L				
PRELUDE		87/04~91/08	BA4-100/110 BA5-100/110	R		341072		
				L		341073		
		91/09~96	BB1/2/3/4, BA8/9	R		341177		341179
				L		341178		
		96/10~	BB5/6/7/8	R				341179
				L				
STREAM		01~	RN# 1.7L	R		331012		341298
				L		331013		

HYUNDAI

製造商	車款	年份	規格	R	前		後			
					KYB No.		KYB No.			
					OIL	GAS	OIL	GAS		
HYUNDAI	ATOS/ATOZ	97/11~	chassis No.KMHA***	R		333256		343301		
				L		333257				
		98/10~	PRIME chassis No.KMHA***	R		333298		343301		
				L		333299				
		00~	ALL for Mexico	R		333298		343432		
				L		333299				
		CLICK/GETZ/TB		02/09~	ALL	R		333506		343398
						L		333507		
				02/09~	GLE/GVS 1.1L, GLS/GLX 1.3L for India	R		333506		
						L		333507		
COUPE/TIBURON		96~01/07	J2 1.6L, 1.8L, 2.0LCoupe chassis No.KMHJG, 2/3, 1, F/K/M, P*U	R		333205		333207		
				L		333206		333208		
EF SONATA		98/09~99/06	1.8L/2.0L/2.5L ALL Except ECS, chassis No.KMHE, M/N/P,41,A/B/G/S,P, W/X,A			341245		341246		
		99/06~00/05	1.8L/2.0L/2.5L ALL Except ECS, chassis No.KMHE, M/N/P,41,A/B/G/S, P,X/Y,A			341280		341246		
		00/06~01/03	1.8L/2.0L GL Except ECS, chassis No.KMHEM41, A/B/S,P,Y/1/2,A			341280		341246		
		00/06~05/02	2.0L/2.5L/2.7L GLS & GDS Except ECS, chassis No. KMHE, N/P,41,B/G/S,P, Y/1/2, A			341280		341281		
ELANTRA/AVANTE XD		00/05~	GF-XD18/20 chassis No. KMHD, M/N, 4/5, 1, A/D, P*U	R		333205		333500		
				L		333206		333501		
EON		12~	ALL for Panama					343432		
EXCEL/ACCENT		94/07~97/05	X3 1.3L, 1.5L	R		333211		332080		
				L		333212		332081		
		97/05~99	X3 1.3L, 1.5L	R		333211		332094		
				L		333212		332095		
		GALLOPER		91/10~	2.5D, 2.5TD, 2.6chassis No.KMJK			344119		554061
								344119		554061
92~	2.5D, 2.5TD, 2.6 chassis No.KMJK Rear Coil Spring Suspension					344119		554061	344116	
GRACE						554047		444026		
GRANDEUR		92/06~	S20			335008		551076		
GRANDEUR XG/GRANDEUR XG25/GRANDEUR XG30		98/09~99/06	2.0L/2.5L/3.0L ALL Except ECS, chassis No.KMHF, T/U/V, 41, A/C/D, P, W/X, A			341245		341246		
		99/06~00/05	2.0L/2.5L/3.0L ALL Except ECS, chassis No.KMHF, T/U/V, 41, A/C/D, P, XY, A			341280		341246		
		00/06~	2.0L/2.5L GL Except ECS, chassis No.KMHF, T41, A/C, P, Y/1/2, A			341280		341246		
00/06~	2.0L/2.5L/3.0L GLS & TOP Except ECS, chassis No. KMHF, U/V, 41, A/C/D, P, Y/1/2, A			341280		341281				

製造商	車款	年份	規格	R L	前		後	
					KYB No.		KYB No.	
					OIL	GAS	OIL	GAS
	H1 STAREX							
		97~	2WD chassis No.KMJ*** with Short Wheel Base and Rear Coil Spring Sus.			344285		
		97~	2WD chassis No.KMF***/KMJ***with Long Wheel Base and Rear Leaf Spring Sus.			344285		344286
		97~05	4WD			344285		
	H100/PORTER							
		93~	Minibus/Van/Truck				444023	553116
	LANTRA/ELANTRA							
		90/12~95/04				334019		341084 551074
	LANTRA/ELANTRA/AVANTE							
		95/05~00/04	J2 1.5L, 1.6L, 1.8L, 2.0L chassis No.KMHJF/W***	R L		333205 333206		333207 333208
	MATRIX							
		01~	1.6L, 1.8L, 1.5D	R L		333366 333367		333504 333505
	PONY EXCEL							
		85~89/07				333057		
		89/08~94/06	X2 1.3L, 1.5L					553112
	PORTER							
					444022	344332		344333
	SANTA FE							
		00/07~	GF-SM24/27 chassis No.KM*S*8/G**P*	R L		334500 334501		344314
		06/03~	2WD/4WD All without Height Control	R L		334506 334507		344500
	SANTAMO							
		95~	chassis No.KMYMS			334070		343262
	SONATA I							
		88~93	Y2 chassis No.KMHAF, KMHBF withABS			334058		
		93/07~	Y3 chassis No.KMHCF, KMHDF			334141		341192
		02~	Y1,Y2 2.0L			334058		
	SONATA II, III/MARCIA							
		94/06~				334141		341192
	TERRACAN							
		01/05~	2.5TD, 2.9CRDi, 3.5i			344453		344454
	TRAJET XG							
		99~	GF-F20/27 chassis No.KMD(H/J)MG(H/J/F)	R L		334237 334238		344297
	TUCSON/JM							
		04/07~	2.0i-16V, 2.0 CRDi for 2WD & 4WD, 2.7 V6 for 4WD	R L		334502 334503		334504 334505
	VERACRUZ/ix55							
		07~	ALL	R L				344500
	VERNA/ACCENT							
		99/09~	chassis No.KMHC, F/G/H, 3/4/5, 1, F/G/B, P*U	R L		333304 333305		332108 332109
	XG							
		02/09~02/11	Facelift 2.5i/3.0i for Europe			341280		

ISUZU

製造商	車款	年份	規格	R L	前		後	
					KYB No.		KYB No.	
					OIL	GAS	OIL	GAS
ISUZU								
	BIGHORN/TROOPER							
		86/11~91	UBS12/52 (Exc.Heavy Duty Sus.)			444132		
		92~	UBS69					554127
		98/02~	UBS 26/73, V6-3.5/3.0D, 4WD Wagon					554127
	BUS							
						446056		
		~65	BR(LEAF SPRING)			446007		447017
		58~65	BD					447016
		59~	BX			445055		447017
		59~64	BB			445055		
		59~70	BA(LEAF SPRING)			446007		447017
		62~80/01	BU(LEAF SPRING)			446007		
		64~	BF, BS			446007		447017
		71~80/01	BA(LEAF SPRING)			446007		
	ELF							
		61~69	TLSeries All (Except TL60Series)			444198		444057
		66~69	TL60Series			444198		445047
		70~75/07	TL40, 50Series(D. Tire)					444057
		70~75/07	TL60Series(D.Tire)					445047
		70~75	TL MICRO BUSSeries			444198		444057
		70~80/01	KSSeries(ELF350)			445016		
		72~	KUD, KUV MICRO BUSSeries			444057		
		74~75/07	TL20Series					344333
		80/02~84/05	TL34Series(FLAT LOW)					444023
		80/02~84/05	KS, KTSeries(Except FLAT LOW 15A, 16A, 24A, 25A, 26A)			445016		
		07~09	300					444269
	ELF150/ELF250							
		84/06~	NKR55EU1			444213		
		86~97	NKR55			444213		444180
		96~	NKR66E			444261		
	ELF250 WIDE/ELF350							
		84/06~	NPR57, 58, 59			445016		
	FASTER/CAMBO/BRAVA/RODEO							
		88/04~	TFSSeries(4WD)			443216		
	GEMINI							
		74/11~87/01	PF50, PF60, PT60					553089
	GIGA							
			FXH			446056		
	HIGH-PACK VAN							
		83/01~	UFR52G					444084
	JOURNEY(LIGHT BUS)							
		66~67	BLSeries All			444198		
		72~80/01	BL, BESeries			445016		444057

製造商	車款	年份	規格	R L	前		後	
					KYB No.		KYB No.	
					OIL	GAS	OIL	GAS
ECLIPSE								
		00~	D50A	R L				341164
		06~07	GT SPYDER V6 3.8L	R L		335057 335058		341404
ECLIPSE/DODGE AVENGER								
		94~99	D40A		441086	341141		341165
ECLIPSE/EAGLE TALON								
		89/09~94/03	D20A, D21A, D22A(2WD)		634023	334030	441114	341114
		89/09~94/03	D27A(4WD)		634023	334030		341121
		94~99	D30A(2WD)			341163		341165
		94~99	D30A(4WD)			341163		341164
FTO								
		94~97	DE2A, DE3A	R L		334390 334391		341140
		97~	DE2A, DE3A	R L		334491		
GALANT								
		92/02~96	E5#A, E64A, E75A, E8#A(incl4WD, 4WS&with ABS)		441086	341141	441087	341142
		04~	ES&ES DIAMOND 4 CIL 2.4L 16V for Mexico	R L		334432 334433		341373
		07~	DJ1A	R L		339173 339174		341491
GALANT/ LEGNUM								
		96/10~	EA#A/W(2WD) incl. Estate		441086	341141		341213
		96/10~	EC#A/W(4WD) incl. Estate			341240		341241
GALANT/MAGNA/SIGMA								
		83/08~87	E11~15A					341054
		84/05~87	E14A, E15A, E16A					341054
		87/08~92	E31A, E32A, E33A, E34A, E35A(2WD)		634023	334030		341054
		88/02~92	E37A, E38A, E39A (4WD incl. 4WS w/o ABS)					341121
		88/02~90/05	E37A, E38A, E39A (4WD incl. 4WS with ABS)					341121
		90/06~92	E37A, E38A, E39A (4WD incl. 4WS with ABS)			334044		341121
GALANT/SAPPORO/LAMBDA/SIGMA								
		73/04~76/12	A112V(VAN)				443070	553249
GRANDIS/SPACE WAGON/NIMBUS								
		04/01~	NA4W STD All	R L		334456 334457		343436
		04/01~	NA4W with High Ground Sus.All	R L		334458 334459		343437
GTO/3000GT/DOGE STEALTH								
		91~97	Z15A, Z16A			335013		341183
JEEP								
		61~	J20, J22, J24, J25, J26, J30, J32, J34, J36, J38, J44, J46		443070	553249		
		70~	J54, J57, J58, J59		443070	553249	443089	
		73~	J52, J53, J55, J56, J58		443089		443089	
		81~	J24, J27, J26, J37, J44, J47		443070	553249		
JUPITER								
			T10		444023		444023	
L200/FORTE/STRADA/TRITON								
		96/01~	K62T(2.0, 2WD), K64T(2.5D, 2WD), K65T(2.4, 2WD), K67T(2.8D, 2WD)			344389		
		05/12~	KA5T, K9T, KB4T, KB9T				443258	553189

製造商	車款	年份	規格	R L	前		後	
					KYB No.		KYB No.	
					OIL	GAS	OIL	GAS
L300/DELICA								
		68~77/08	T100, 100V, T120, 120V		444022	344332 553278		
		71~79/06	T120		444022	344332 553278		
		79/06~86/05	L031P, L032P, L038P, L068P (2WD Van/Truck)		444022	344332 553278		553116
		80/05~86/05	L031PUE(2WD Truck)		444022	344332 553278		
		79/06~86/05	L032P, L038P(2WD Mini Bus)		444022	344332 553278	443089	
		83~86/05	L35G, L037G(4WD Mini Bus/Van)			344119 554061		
		87/01~	P0#V, P1#V(2WD Van Except Flat Low)					553116
		86/06~	P2#W/V, P35W, P45V(4WD Mini Bus/Van)			344111		343226
		86/06~	L036P, L039P, L063P, L069P(2WD Truck)		444022	344332 553278		553116
		86/06~	L036P, L039P, L063P, L069P (2WD Truck High Cargo Deck/Loading Platform)		444022	344332 553278		
		86/06~89/01	L039G(4WD Truck)			344119 554061		
		89/02~	L039G(4WD Truck)			344119 554061		
		94/06~	P05T, P13T, P15T(2WD Truck)		444137	554102		553116
L400/SPACE GEAR								
		94/06~	PA3W, PA4W, PA5W(2WD, Rear Coil Spring Suspension)		444137	554102	443283	553210
		94/06~	PA3V, PA5V, PB3V, PB5V (2WD, Rear Leaf Spring Suspension)		444137	554102		553193
		94/06~	PD4W, PD5W(4WD, Rear Coil Spring Suspension)			554103	443284	553211
		94/06~	PD4V, PD5V(4WD, Rear Leaf Spring Suspension)			554103		
		98/03~02/05	PA5W for General				443283	553210
		99/09~05/11	PB3V, PB4V, PB5V, PC3W, PC5W for General					553193
LANCER								
		76/09~78/12	A73, 73A, 144					443089
		75/03~81	A72, A73, A78 (CELESTE)					443089
		07/04~	CY2A, CY4A, for General, Europe	R L		339104 339105		341444
		07~	for Mexico	R L		339082 339083		341425
LANCER ESTATE/LIBERO								
		92/04~00/05	CB#V/W	R L				343261
		92/04~00/05	CD4V/W(4WD)	R L				343261

製造商	車款	年份	規格	R	前		後	
					KYB No.		KYB No.	
					OIL	GAS	OIL	GAS
	LIGHT ELF/ELF150							
		68~72/08	KA20, 40, 50				444023	
		72/09~	KA41, 51 KAD/G41, 51					344333
		72~	KA501					344333
	MU/WIZARD/RODEO							
		97~	UES25/73, UER25					344299
	TRUCK							
							445055	
		85/05~87/11	FORWARD FRR/FSR11, 12, 13		444203			
							446038	
							445064	
		59~	TXSeries		445055			
		59~	TXD.ESeries All		446007			
		61~	TDSeries ALL TPseries ALL		446007			
		74~	SBRSeries 420		445061			
		80~	840FTR		445061			
		80~	SSH701J				445061	
		83/07~	CXK, CXM, CXZ, CVR14, 17		446034			
		83/09~	FSR, FTR		445064			
		96/01~	CXH for China		446055		446056	
		~97	4BE1		444268		444269	
		06/01~	CYH52TX-7/CYH52TX-12		446056			
			CXG		446056			
			CYE		446056			
							446034	

KIA

製造商	車款	年份	規格	R	前		後	
					KYB No.		KYB No.	
					OIL	GAS	OIL	GAS
KIA								
	BESTA							
					443215	553223		
	CARENS							
		99~02	KNHFC	R		333314		333264
				L		333315		333265
	CARNIVAL/SEDONA							
		98~	KNHUP 2.5V6, 2.9Diesel MiniVan Without ABS	R		335024		344296 554145
				L		335025		
		99/01~	KNHUP 2.5V6, 2.9Diesel MiniVan With ABS	R		335042		344296 554145
				L		335043		
		02~05	EX, LX ALL for USA	R				344296 554145
				L				
	CARSTAR/JOICE							
		00~	KMYMS(M300E)		634042	334070		343262

製造商	車款	年份	規格	R	前		後	
					KYB No.		KYB No.	
					OIL	GAS	OIL	GAS
	CREDOS I II/CLARUS							
		96/05~00	KNAGC/K9A* ALL except Drum Brake	R		334231		334233
				L		334232		334234
		96/05~00	KNAGC/K9A* 1800 With Rear Drum Brake	R		334231		
				L		334232		
	OPTIMA/LOTZE/MAGENTIS							
		00/06~	KMHE*41*P**			341280		341281
	PICANTO							
		04/01~	1.0L/1.1L LX, EX	R		332500		343405
				L		332501		
	PREGIO							
		97~	KNHTR			341247		344292
	PRIDE							
		87~91	DA	R		332041		341079
				L		332042		
		96~	DA	R		332054		341079
				L		332055		
	RIO/RIO RX-V							
		02/07~03/11	KNADC22/24;1.3L, 1.5L 4DSedan & 5DHatchback	R		333512		
				L		333513		
		03/11~05	1.3Li L, LX, LS & 1.5Li LS Sedan & Hatchback for Australia & Europe	R		333512		343424
				L		333513		
		03~	STYLUS for Colombia	R		333512		343424
				L		333513		
	SEPHIA I /MENTOR/LEO							
		93~97	FA Without ABS	R	633168	333109	633170	333111
				L	633169	333110		
	SEPHIA II/SHUMA							
		98~00/05	K2BA/B/C/D	R		333262		333264
				L		333263		333265
	SORENTO							
		02/04~	KNA/E/C***1/2/3**2.4/3.0/2.5Diesel 2WD SUV without Self Levelizer	R		341364		
				L		341365		
		02/04~	2.5CRDTi, 2.4i, 3.5i	R		341364		344451
				L		341365		
	SPECTRA/SHUMA							
		00~01	ALL for USA	R		333314		333264
				L		333315		333265
		02~03	without ABS, Anti-Lock Brakes for USA	R		333316		333302
				L		333317		333303
		02~03	with ABS, Anti-Lock Brakes for USA	R		333316		
				L		333317		
		04~	ALL for USA	R		333316		
				L		333317		
	SPECTRA/SHUMA II							
		00/06~	KNAF/KNEF	R		333316		333302
				L		333317		333303
		01/05~	KNAF/KNEF for Europe	R		333316		
				L		333317		
	SPORTAGE							
		94/09~99	ALL			341190		554094
		00/10~02/09	ALL	R		341394		554094
				L		341395		

MAZDA

製造商	車款	年份	規格	R	前		後	
					KYB No.		KYB No.	
					OIL	GAS	OIL	GAS
MAZDA								
	121/FESTIVA							
		85/10~91	DA1, DA2, DA3, DAJ Except Adjustable Damper	R		332054		341079
				L		332055		
		86/10~91	DA3V(Cargo)	R		332054		
				L		332055		
	121/METRO/DEMIO/FESTIVA WAGON							
		98/01~99/12	DW3/5W	R		333266		341252
				L		333267		
		00/01~02/12	DW3/5W	R		333266		
				L		333267		
	323/FAMILIA/FORDLASER							
		85/07~89/05	BFTPF, BFSPP, BF7PF	R	633049	333025	632034	332019
				L	633050	333026	632035	332020
		85/07~89/05	BFMPF, BFMSF, BF5P	R	633049	333025		
				L	633050	333026		
		86/12~89/05	BFMP, BFSP	R	633049	333025		
				L	633050	333026		
		85/07~89/05	BF wirh Heightening Road Clearance	R	633049	333025		
				L	633050	333026		
		85/11~87/04	BF5W, BF7V (Wagon/Van)	R	633049	333025		
				L	633050	333026		
		85/11~94	BF3/5/7V, BF5W, BW12 (Wagon/Van)	R	633049	333025		
				L	633050	333026		
		89/01~94/08	BG3/5/7 2WD 3/4Door Normal Sus. & Power	R	633137	333126	633143	333132
				L	633138	333127	633144	333133
		89/06~94/08	BG3/5S, BG3/5P 2WD 3/4Door Normal Sus. & Power	R	633137	333126	633143	333132
				L	633138	333127	633144	333133
		89/06~94/08	BG3/5S, BG3/5P 2WD 3/4Door with Heightening Road Clearance	R	633137	333126		
				L	633138	333127		
	323/FAMILIA/LIATA/FORD LASER							
		94/09~95	BHA# 2WD 3/4/5Door with ABS chassis No.→151007	R		333182		
				L		333183		
		94/09~	BHA# 2WD 3/4/5Door incl. ABS chassis No.151007→	R		333178		333180
				L		333179		333181
	323F/ASTINA/FORD LASER							
		89/06~94/08	BG5/6/8P 2WD 5Door Coupe	R			633143	333132
				L			633144	333133
	323F/ASTINA/LANTIS/LIATA							
		94/09~95	CBAEP, CBA8P (1.8/2.0V6Motor) chassis No.→151007	R		334121		334123
				L		334122		334124
		94/09~98	CBAEP, CBA8P (1.8/2.0V6Motor)	R		334117		334119
				L		334118		334120
	323S/323F/ASTINA/PROTEGE/FAMILIA/FORD LASER							
		98/05~00/12	BJE/3/5P 2WD Sedan/Hatchback	R		333274		333276
				L		333275		333277
		98/05~00/12	BJE/3/5P 2WD Sedan/Hatchback with Heightening Road Clearance	R				333296
				L				333297
		00/12~03/10	BJ 2WD 1.3/1.6/1.8/2.0/2.0D Sedan/Hatchback	R		333350		333276
				L		333351		333277
				R		333350		333296
		00/12~03/10	BJ 2WD 1.3/1.6/1.8/2.0/2.0D Sedan/Hatchback with Road Clearance Up Sus.	L		333351		333297

製造商	車款	年份	規格	R	前		後	
					KYB No.		KYB No.	
					OIL	GAS	OIL	GAS
	626 MILLENIUM/626 NEW MILLENIUM							
		98~05	for Colombia 2.0L	R				334201
				L				334202
	626(CAPELLA)/FORD TELSTAR							
		97/05~02/05	GF 1 (1.8, 2.0, 2.0HP, 2.0TD, 2.5 4SD/5HB Standard Sus.)	R		334197		334201
				L		334198		334202
		97/05~02/05	GF 1 with Heightening Road Clearance	R				334201
				L				334202
		99/04~00/06	GF w/o Ground Clearance sus.	R		334197		
				L		334198		
				R		334197		
		97/10~02/05	GW 1 (1.8, 2.0, 2.0HP, 2.0TD, 2.5 Estate/Wagon) Except Self- Leveling Rear Sus.	L		334198		
	626(CAPELLA)/FORD TELSTAR, PROBE							
		87/03~92	GD6/8/E/F, BT21 2WD	R	634024	334034	634026	334036
				L	634025	334035		
		87/03~92	GD6/8/E/F, BT21 2WD	R		334034		334036
				L		334035		
	626(CAPELLA)/FORD TELSTAR/ASAHI							
		88~96	GD6/8/E/F, BT21 2WD for South America	R			634026	334036
				L				
		88/01~95/06	GV6/8/F Estate / Wagon 2WD	R	634024	334034		
				L	634025	334035		
		95/07~97	GV6/8/F Estate / Wagon 2WD	R		334034		
				L		334035		
	626(CAPELLA)/FORD TELSTAR/MX-6							
		91/08~93	GE 12/14(1.8, 2.0, 2.0D- 2WD-2WS) chassis No.→271863	R	634044	334082	634046	334084
				L	634045	334083		
		93~97/05	GE 12/14(1.8, 2.0, 2.0D- 2WD-2WS) chassis No.271863→	R	634044	334082		
				L	634045	334083		
		91/09~97/05	GE14F (2.5-2WD-2WS)	R	634044	334082		334084
				L	634045	334083		
		91/09~97/05	GE74F (2.5-2WD-4WS)	R	634044	334082		
				L	634045	334083		
	B Series/PROCEED							
		96/03~	2.2i, 2.5D PICK UP 2WD		443216		443305	
	DEMIO/MAZDA 2/FORD FIESTA							
		03/01~07	MAZDA 2(DY), FORD FIESTA(JH)	R		333400		553308
				L		333401		
		07/10~	DE ALL	R		333494		553379
				L		333495		
		12~	Sedan, Hatch Back & Sports Touring	R		333494		
				L		333495		
	DEMIO/VERISA							
		03/01~07	DEMIO (DY), VERISA (DC)	R				553308
				L				
	E Series/BONGO							
		77~80/02	BA2Series(MULTI VAN) BA2V8H				443089	
	E Series/BONGO/FORD J80/SPECTRON							
		83/09~97/04	2WD WAGON/VAN/PICK UP with Rear Single TireSSF8, SS48, SS88, SEF8, SSE8		443215	553223		553120
		83/12~97/04	2WD VAN/PICK UP with Rear Double Tire SE48T, SEF8T, SSF8W			553223		553193
		87/12~97/04	4WD WAGON/VAN/PICK UP SS28, SS88, SSE8, SSF8					553120

製造商	車款	年份	規格	R L	前		後	
					KYB No.		KYB No.	
					OIL	GAS	OIL	GAS
LANCER/COLT/MIRAGE								
		91/08~96	CA#A, CB#A, CC#A, CD#A	R			441085	341140
				L				
		91/08~96	CA#A, CB#A, CC#A, CD#A	R				341140
				L				
		91/08~96	CA4/5A, CB4/5A, CC4/5A, CD4/5A	R		334072	441085	341140
				L		334073		
		91/08~96	CA#A, CB#A, CC#A, CD#A with High Ground Clearance Sus.	R				341145
				L				
		94/09~96	CA#A, CB#A, CC#A	R			441085	341140
				L				
		94/09~96	CA#A, CB#A, CC#A	R				341140
				L				
		94/09~96	CA#A, CB#A, CC#A	R				341140
				L				
		95/08~97/03	CJ#A, CK#A, CM#A	R		333224	441085	341140
				L		333225		
		95/08~00/09	CM#A	R				341140
				L				
		95/08~97/06	CJ#A, CK#A, CM#A with High Ground Clearance Sus.	R	633191		441112	
				L	633192			
		95/08~00/09	CJ#A, CK#A, CM#A with High Ground Clearance Sus.	R		333290	441112	
				L		333291		
		96/12~	CJ#A, CK#A, CM#A with High Ground Clearance Sus.	R		333288	441112	
				L		333289		
		97/04~00/09	CJ#A, CK#A, CM#A	R			441085	341140
				L				
		97/04~00/09	CJ#A, CK#A, CM#A	R			441085	
				L				
		97/04~00/09	CJ#A, CK#A, CM#A	R				341140
				L				
		98~00/09	CJ#A, for Indian Market with High Ground Clearance Sus.	R		333342		341313
				L		333343		
LANCER/LANCER CEDIA								
		00/09~	CS1A(1.3), CS2A(1.5), CS3A(1.6), CS5A(1.8Hong Kong without Size-Up Al. Wheel)			334490		341342
		00/09~	CS1A(1.3), CS3A(1.6) for G.C.C., Egypt, Argentin and Optional High Ground Clearance Sus.			333381		341318
		00/12~03	J114, J116E, J118F/G/V			334490		341342
		00/12~05	J104F, J106F, J108F/G/V			333382		341342
		92/08~	CB2A, CB4A	R				341145
				L				
		92/08~	CB5A	R		334072		341145
				L		334073		
		01/07~	CS5A(1.8)			333381		341318
		03/06~	CS1A(1.3Li), CS3A(1.6Li) STD/SPORT			334420		341368
		03/06~	CS9A(2.0Li Sport)			334369		341368

製造商	車款	年份	規格	R L	前		後	
					KYB No.		KYB No.	
					OIL	GAS	OIL	GAS
MAGNA/VERADA								
		96/04~00/08	Made in Australia TE, TF, TH V6 Sedan except Sports	R		334271		341274
				L		334272		
		97/06~00/08	Made in Australia TE, TF, TH V6 Station Wagon	R		334271		
				L		334272		
		03/06~	Made in Australia TL-ES & LS Sedan, KL-Ei, Xi, GTVi Wagon	R		334271		
				L		334272		
OUTLANDER/Citroen C-CROSSER/PEUGEOT 4007								
		05/12~	CW5W for General	R		339124		341454
				L		339125		
		07/02~	2.0DI-D, 2.2DI-D, 2.4i	R		339080		349040
				L		339081		
PAJERO SPORT/MONTERO SPORT/CHALLENGER/NATIVA								
		96/05~	K86W, K94W, K96W, K97W, K99W for All			344294		344295
		98/08~	K94W, K96W, K99W for General, Australia&New Zealand			344294		
		98/06~99/05	K85W, K86W for General			344294		
		99/06~04/07	K96W, K99W for General					344295
		00/06~05/12	K96W for General			344294		
PAJERO/SHOGUN/MONTERO								
		83/01~91	L041G, L042G, L043G, L044G, L046G, L047G, L048G, L049G			344119 554061		
		88/11~91	L141G, L144G, L146G, L149G(Rear Coil Spring Suspension)			344119 554061		344116
		91/01~99/08	V1#V/W, V3#V/W			344222		
		90/12~99/08	V2#C/W, V4#W(Rear Coil Spring Suspension)			344222		554092
		99/08~06	V64W(2.5TD Short) V65W(3.5 Short) V68W(3.2TD Short) V74W(2.5TD Long) V75W(3.5 Long) V78W(3.2TD Long)			341251		344300
		04/06~06/12	V64W, V65W, V66W, V73W, V75W, V76W, V77W, V78W for General					344300
ROSA								
			BE4					444109
		95~	BE4			444182		444183
		65~67	B10, 20, 21, 22			444012		
		68~	B12, 13, 14, 15, 16					444024 344325
		68~	B23, 24			444023		
		74~79/03	B200Series					444023
		76~79/03	B360					444084
		76~79/03	B360					444084
SANTAMO								
		99~	2WD		634042	334070		343262
		99~	4WD			334071		343262
SIGMA/DIAMANTE								
		94/11~99/08	F31/36A, F46/47A(4WD)					341274
SPACE RUNNER(RVR)								
		91/06~95/05	N10#			334071		
		91/09~97/09	N11W, N13W, N18W(2WD)		634042	334070		343262
		91/09~97/09	N21W, N23W, N28W(4WD)			334071		343262

製造商	車款	年份	規格	R L	前		後	
					KYB No.		KYB No.	
					OIL	GAS	OIL	GAS
E2000, E2200/BONGO/FORD J80/SPECTRON								
		97/03~99	2WD VAN/PICK UP with Rear Single Tire		443215	553223		
		97/03~99	2WD VAN/PICK UP with Rear Double Tire		443215	553223		
MAZDA 3/AXELA								
		03/11~	1.4i, 1.6i, 1.6D, 2.0i	R L				343412 551105
MAZDA 5/PREMACY								
		05/06~	1.8i, 1.6i, 2.0i, 2.0CD for Europe	R L				343412 551105
		11~	ALL for Panama	R L				343412 551105
MAZDA 6/ATENZA								
		02/05~03/04	GG3S/GY3W(2.0, 2.3, 2.5-2WD Sedan/ Hatchback/ EstateWagon) Except Self-Leveling Rear Sus.	R L		341351 341352		344363
		03/05~	GG3S/GY3W(2.0, 2.3, 2.5-2WD Sedan/Hatchback/ EstateWagon) Except Self-Leveling Rear Sus.	R L		341351 341352		344363
		02/05~	GG3S/GY3W(2.0, 2.3, 2.5-2WD Sedan/Hatchback/ EstateWagon) with Heightening Road Clearance Except Self-Leveling Rear Sus.	R L		341332 341333		344363
		02/08~	LA-GY3W, 2.0, 2.3-4WD EstateWagon Except Self-Leveling Rear Sus.	R L		341332 341333		
		07~	2WD ALL	R L		341449 341450		349063
		09~	2.5L for Mexico	R L		341449 341450		
MAZDA 8/MPV								
		89/11~99/08	LVEW	R L		335009 335010		554119
		89~99/08	LVEW	R L		335011 335012		554126
		99/08~	LW(2.0/2.5 2WD)	R L		334282 334283		345024
		99/08~	LW(2.0/2.5 4WD)	R L		334282 334283		345024
		02/03~	LW(2.3i/2.0 DiTD)	R L		334418 334419		345024
PREMACY								
		99/07~01/06	CP# (1.9, 2.0, 2.0TD 2WD)	R L		333268 333269		334259 334260
		01/07~	CP# (1.9, 2.0, 2.0TD 2WD)	R L		333350 333351		334259 334260
TRIBUTE/FORD ESCAPE/FORD MAVERICK								
		01/03~	Y11;EPEW (2.0, 2/4WD)/EPFW(V6-3.0, 2/4WD)	R L		334333 334334		344356
		04/01~	ZB 2.3Lt.Auto XLS, XLT&Limited 4WD Wagon for Australia	R L		339068 339069		344356

MITSUBISHI

製造商	車款	年份	規格	R L	前		後	
					KYB No.		KYB No.	
					OIL	GAS	OIL	GAS
MITSUBISHI								
ADVENTURE								
		97~00	VB2W		444022	344332 553278		553193
		00~	VB5W (2.0/2.5D SUV)		444022	344332 553278		
AIRTREK/OUTLANDER								
		01/03~	LS, XLS 4WD Wagon			334368		341348
		02/12~04/05	CU4W for General			334368		
		03/06~	CU2W, CU5W (2WD/4WD)			334398		341361
BUS								
						447014		
		67~72	R470, 480, B800, 801, 810 (LEAF SPRING)			447002		
		76~	MP118, MM116, RP118			447002		
		76~79/09	MP117K, M, N			447002		
		82/10~90	MS713, 715					447021
			RM117				347001	446060
			RM117			446062		447031
CANTER								
			T720					444024
		62~67	T720, 722, NB720(MICRO BUS)					444024
		68~78/11	T92, 93, 98, 200(Except CH, CD, CD8, CN, CTN, CPN, CN2) T215, 217(Except CH, CD, CN)					444109
		78/11~82/09	T93, T92, T210F					444109
		80~	FC212, FE111					444109
		82/10~	FE111					444109
		82/10~85/10	FE211, 214, 234					444109
		85/10~	FE425					444170
		98/07~	FE645/647/657/659					444109
			FE82/84/88#					444109
CARISMA (Made in Holland)								
		95/05~99/02	DA1A(1.6L) DA4A(1.9TD)	R L		333221 333222		341204
		95/05~99/02	DA2A(1.8L)	R L		334154 334155		341204
COLT/ COLT PLUS								
		03/06~05/09	Z23A, Z25A, Z27A for General			333476		
		04/12~06/11	Z23W for General			333476		343490
		05/01~05/09	Z27W Turbo for General					343490
		05/10~06/11	Z27W Ralliart version for General					343490
COLT/MIRAGE/LANCER								
		87/09~88/11	C51A, C52A, C54A, C61A, C62A, C64A, C65A			334019		341084 551074
		88/04~92	C51A/V, C52A, C53A, C54A, C58A, C61A, C62A, C63A, C64A, C65A, C68A			334019		341084
		88/05~88/11	C5#A, C6#A			334019		
		88/04~92	C5#A, C6#A			334019		
		87/12~92	C72A, C73A, C74A, C77A, C82A, C83A(4WD)					341114
		88/04~92	C5#A, C6#A					341084
COLT/MIRAGE/LANCER FIORE								
		77/11~83/10	A152Turbo, A155, A158					553112
CORDIA/TREDIA								
		82/05~87	A210(ECI), A212, A213					553112
		85~87	A215/217(4WD)					553112
DEBONAIR								
		92/06~99	S20A			335008		551076
DION								
		00/01~	CR#			334423		341368

製造商	車款	年份	規格	R	前		後	
					KYB No.		KYB No.	
					OIL	GAS	OIL	GAS
	SPACE STAR							
		00/07~	DG 1.8L without High Ground Clearance Sus.	R				341204
				L				
	SPACE WAGON(VAN)/EXPO/CHARIOT/NIMBUS							
		91/09~97/08	N31W, N33W, N34W, N35W, N38W(2WD)	634042	334070			343262
		91/09~97/08	N41W, N43W, N48W(4WD)		334071			343262
	SPACE WAGON/CHARIOT GRANDIS							
		98/07~00/05	N84W(2WD), N94W(4WD)	R		334235		343312
				L		334236		
		00/06~	N83W, N84W, N94W	R		334392		343312
				L		334393		
	STARION							
					445056			
							446039	
	TRUCK							
			FM		445067			
			FM557		445067			
			T620		444084			
			T720				444084	
		70~76/03	T620, T62, 63, 65Series		444023			
		80/03~89	FP413, FN428, FP415, 418, FV413		446035			
		84/02~90	FK415, FM515		444193			
		91/01~	FP415 for China				447027	
		95~	FP418		447026		446054	
		98/01~	FP515 for China				447028	

NISSAN

製造商	車款	年份	規格	R	前		後	
					KYB No.		KYB No.	
					OIL	GAS	OIL	GAS
NISSAN	350ZX/FAIRLADY							
		03/07~	Z33	R		341366		344455
				L		341367		
	AD WAGON/AD RESORT/AD VAN/WINGROAD							
		94/07~	HY10/Y10	R	633115	333089		343240
				L	633116	333090		553258
		02~	VY11/VAY11	R		333310		
				L		333311		
	ALTIMA							343465
		02~05	L31 for Mexico 3.5L	R		334336		
				L		334337		
	ATLAS							
		82/02~	F22(Single Tire/Low Floor)			554047		
		82/02~	F22(Single Tire)			554047		
		82/02~	F22(Double Tire)		444054	554047		
	ATLAS/CONDOR							
		81/12~88	MGH40, FGH40, RFGH40, RMGH40(Double Tire/Long Body)				446046	
	BLUEBIRD SYLPHY							
		01/05~	G10	R				341279
				L				
		06~	G11 for China	R		333427		343465
				L		333428		
		06~	G11 for Asia	R				343465
				L				

製造商	車款	年份	規格	R	前		後	
					KYB No.		KYB No.	
					OIL	GAS	OIL	GAS
	BLUEBIRD WAGON/PRIMERA WAGON/AVENIR							
		90/07~98/01	W10	R				343248
				L				
	BLUEBIRD/ALTIMA							
		91/09~95/08	HU13, PU13 (Moter;SR20DE)	R	634076	334222		334135
				L	634077	334223		334136
		91/09~95/08	U13, EU13, SU13(Moter;GA16DS, ST18DE, CD20)	R		333260		
				L		333261		
	BUS							
					445068			
		76~90	CP80		445068			
	CABALL							
		66~67/09	C240Series(Single Tire Truck/Micro Bus/Van)		444024	344325	444024	344325
		67/10~76/05	C240Series(Single Tire GC Micro Bus/Van)				444024	344325
		67/10~76/05	C240Series(Single Tire GC Micro Bus)				444084	
		71/10~76/05	C240Series(DoubleTire Short Chassis Except Bus, Damp)					344333
		76/05~78/01	C340Series(Single Tire Bus)				444084	
		76/05~81/12	C340Series(Single Tire Truck)				444084	
	CABSTAR/HOMER							
		65~67	T640Series				444012	
		78/04~81/12	F20Series			554047		
		92/07~95/07	F23Series			554047		
		95/07~97/08	F23Series			554047		
		06/09~	2, 5 tdic 81kw		444322			
		06/09~	2, 5 tdic 96kw		444322		443467	
	CLIPPER							
		58~65	T63Series				444012	
		66~76/04	T65Series, D65Series, T40Series(Single Tire)				444023	
		69/02~73	T660, T661, D660, D661 (Double Tire Short Chassis)					344333
	DATSUN TRUCK(Pick-up)/720							
		82/01~85/08	Y720(4WD)					553120
	ELGRAND							
		04/08~	E51 for Hong Kong	R		335046		344478
				L		335047		
	FUGA/INFINITI M35/INFINITI M45							
		05/03~	Y50	R		341441		349053
				L		341442		
	GLORIA/CEDRIC							
		71/02~79/02	230, 330, 331, 332Series (Except VAN, Include WAGON)			554022		554023
		71/02~79/02	V230, 330, 331Series (VAN)			554022	444012	
		83/06~87/06	WPY30, V#Y30 (Wagon&Van)					554023
	GLORIA/CEDRIC/280C							
		79/06~83/06	W430, WH430 (WAGON; Rear Leaf Spring Sus.)					554023
		79/03~83/06	V430, VR430, VH430(VAN;Rear Leaf Spring Sus.)				444012	
	INFINITI FX35/FX45							
		06/08~	S50	R		339055		349027
				L		339056		

製造商	車款	年份	規格	R	前		後	
					KYB No.		KYB No.	
					OIL	GAS	OIL	GAS
INFINITI G35								
		03~06	G35 Coupe(w/Sports sus.)	R		341366		344455
				L		341367		
		07~	G35 X AWD	R				349089
				L				
		07~	G35 RWD	R		340020		349096
				L		340021		
JUNIOR								
		62~69	40, 41Series					444012 553257
		70~79/09	140, N140					444026
		70~79/09	140, N140			554047		
LIVINA GENISS/GRAND LIVINA								
		06~	1.5L/1.6L/1.8L ALL for ASIA	R		333429		343466
				L		333430		
		06~	1.5L/1.6L/1.8L ALL for ASIA	R		333390		
				L		333391		
		06~	1.5L/1.6L/1.8L ALL for ASIA	R		333390		343466
				L		333391		
MAXIMA								
		04~	Auto Trans (5-Speed)	R		334336		344450
				L		334337		
MAXIMA/810								
		88/10~91/10	HJ/EJ30,J30	R		334484		
				L		334485		
MAXIMA/810/INFINITI I30/CEFIRO								
		94/08~98/12	A32	R		334480		341202
				L		334481		
		98/12~02/08	A33	R		334366		341341
				L		334367		
		98/12~01/01	CA33 for North America, 3.0-V6Motor	R		334265		341271
				L		334266		
		01/02~	CA33 for North America, 3.5-V6Motor	R		334366		341341
				L		334367		
		98/12~01/01	CA33	R		334265		341271
				L		334266		
MICRA/MARCH								
		92/01~02/02	HK11,K11	R	632079	332061		343249
				L	632080	332062		
		10~	K13	R		332141		348029
				L		332142		
MILER								
		65~71	T44Series					444023
MURANO								
		03~	TZ50 2.5L FF, PZ50 3.5L FF, PNZ50 3.5L 4WD	R		334380		344439
				L		334381		
		06/01~	Z50 for General	R				344439
				L				
PRESEA								
		93/12~95/04	R10	R	633115	333089		
				L	633116	333090		
		95/04~99/10	R11	R		333192		341194
				L		333193		
PRESIDENT								
		67~82	150, 250, 251, 252Series					444198
PRIMERA WAGON/BLUEBIRD WAGON								
		97/09~	WP11			341120		
		97/12~	WNP11 (4WD)			341120		
PRIMERA/BLUEBIRD/INFINITI G20								
		95/09~	P11/U14			341120		341186
		95/09~	NP11/NU14 (4WD)			341120		
PRIMERA/INFINITI G20								
		90/02~96	HP10(Moter,SR20D)	R		341120		334056
				L				334057
		90/06~96	EP10 (Moter,GA16D, SR18D, CD20) without ABS			341120		
		94/09~96	EP10 (Moter,GA16D, SR18D, CD20) with ABS			341120		
		90/10~92/09	HNP10 (4WD)			341120		

製造商	車款	年份	規格	R	前		後	
					KYB No.		KYB No.	
					OIL	GAS	OIL	GAS
QASHQAI/DUALIS								
		06/12~	1.6/2.0L, 1.5LDci	R		339196		
				L		339197		
		06/12~	2.0LDci	R		339196		
				L		339197		
		08/03~	2.0L for China	R		339196		349097
				L		339197		
QASHQA+2/DUALIS+2								
		08~	1.6L/2.0L (RU-UA)	R		339196		
				L		339197		
		09~	ALL	R		339196		
				L		339197		
QUEST								
		93~98	Motor,V6-3L, Mini Van	R		334486		344055
				L		334487		
		04~05	S/SE/SL Minivan 3.5L for USA	R		334454		344479
				L		334455		
		05/04~	V42 for China	R		334454		344479
				L		334455		
ROGUE								
		07/04~	S 2.5 GAS L4	R		339196		349097
				L		339197		
SILVIA/GAZELLE								
		79/02~83/07	S110, PS110, KS110, US110					553023
SKYLINE								
		03~06	V35 Coupe(w/Sports sus.)	R		341366		344455
				L		341367		
SUNNY TRAVELLER/AD WAGON/AD RESORT/AD VAN								
		90/11~99/05	WFY1/WY10(2WD)	R	633115	333089		343240
				L	633116	333090		553258
		90/11~99/05	WFNY10/VFNY10/VSY10 (4WD)	R		333091		
				L		333092		
SUNNY/SENTRA								
		77/10~80/10	GB, B310, KB310, KHB310, HB310(Except GX)					553023
		77/10~81/10	PB, KPB310(1500) HB310X, KHB310X (GX)					553023
SUNNY/SENTRA/ALMERA								
		95~99	AB14/AN15 (2WD incl. Mexico Built)	R				341194
				L				
		95/01~97/07	AB14/AN15 (2WD)	R		333192		341186
				L		333193		
		97/08~00/02	AB14/AN15/AR11(2WD)	R		333238		341226
				L		333239		
		98/10~	B15 (2WD) 1.3/1.5	R				341279
				L				
		98/10~	B15(2WD) 1.8	R		333308		341279
				L		333309		
		98/10~	B15(2WD) 1.6(SR16VE)	R		333308		
				L		333309		
		00/01~01/02	N16 1.5/1.8 3/5Door for Europe	R		333308		341282
				L		333309		
		01/03~	N16 1.5/1.8 3/5Door for Europe	R		333310		341282
				L		333311		
		00/01~00/05	N16 1.5/1.8/2.2Di 4Door for Europe	R		333308		341279
				L		333309		
		00/06~	N16 1.5/1.8/2.2Di 4Door for Europe	R		333310		341279
				L		333311		
		00/01~	N16 2.2Di 3/5Door for Europe	R		333310		
				L		333311		
		00~	B15/N16(2WD, Mexco Built)	R		333344		341279
				L		333345		
		11~	N17T	R				348029
				L				
		02~	GXE/CA 1.8L for USA	R		333310		341279
				L		333311		
		02~05	SE-R 2.5L for USA	R		333394		341279
				L		333395		

製造商	車款	年份	規格	R	前		後	
					KYB No.		KYB No.	
					OIL	GAS	OIL	GAS
		02~05	SE-R Spec V 2.5L for USA	R		333310		341279
				L		333311		
		03~	XE(with ABS) 1.8L/LIMITED EDITION 2.5L for USA	R		333310		341279
				L		333311		
		04~	SSeries ALL for USA	R		333310		
				L		333311		
SUNNY/SENTRA/CHERRY/PULSAR								
		86/06~90/09	B12/N13/WB12	R	632040		632046	
				L	632041		632047	
SUNNY/SENTRA/CHERRY/PULSAR/100NX								
		90/10~94/12	B13/N14 (2WD/1.3, 1.4, 1.5, 1.7D)	R	633115	333089	632072	332056
				L	633116	333090	632073	332057
		90/10~94/12	B13/N14 (2WD Without ABS/1.5, 1.6)	R	633115	333089		334045
				L	633116	333090		334046
		90/10~94/12	B13/N14 (2WD With ABS/ 1.5, 1.6, 1.8, 2.0)	R	633115	333089		334047
				L	633116	333090		334048
		90/10~94/12	NB13/NN14 (4WD Except Gti-R)	R		333091		
				L		333092		
		90/10~94/12	RNN14 (2000 Turbo 4WD Gti-R)	R		333091		
				L		333092		
		00/07~	N16	R		333310		341279
				L		333311		
TEANA/CEFIRO/MAXIMA								
		03/10~09/03	J31	R		334403		344444
				L		334404		
		09/04~	J32	R		339228		348024
				L		339229		
TERRANO/PATHFINDER								
		86/08~	WBYD21, WNYD21, VBYD21		443253			
		87/10~93	WBYD21, WNYD21, WHYD21, VBYD21(Euro & N.America)			344200		
TERRANO/PATHFINDER/INFINITI QX4								
		95/09~99/01	LR50, PR50	R		335015		334388
				L		335016		554129
		97/05~99/01	R50	R		335022		343388
				L		335023		554129
		99/02~	R50 for EU	R		335030		343379
				L		335031		553303
		99/02~	R50 for ME	R		335032		343379
				L		335033		553303
		01/08~02/07	R50 for General	R		335032		343379
				L		335033		553303
TERRANO II/MISTRAL								
		93~	R20			344200		
TIIDA/TIIDA LATIO/VERSA								
		05/04~	C11/SC11 for China	R		333390		
				L		333391		
		08/01~	C11Z for China	R		333429		343466
				L		333430		
		05/04~	C11/SC11 for General/ Taiwan, S/SL for USA	R		333390		343465
				L		333391		
		06~	C11 for Mexico	R		333390		
				L		333391		
		06~	C11/SC11 for Asia	R		333390		
				L		333391		
		12~	1.6L for USA	R				348029
				L				

製造商	車款	年份	規格	R	前		後	
					KYB No.		KYB No.	
					OIL	GAS	OIL	GAS
	TRUCK							
		69~	780Series			445016		
		72~79/10	T80, 81, PT81, TC81, 6TW, 6TV, 5TC, CD3, CV3, 4, 5, 6, CK10, 15, 20, 50, 60, TK20, CW15, 40, 50, 51, TK20, UD, TF30, TZ50, CF30			446030		
		75~	280			446030		
		75~	CK40BT				447020	
		79/10~90	CW52			446038		
		97/07~	PKC212			446038		
							446038	
URVAN/CALAVAN/HOMY								
		78/04~80/08	E20Series			444054	554047	
		80/09~86/08	E23Series				554047	
		80/09~86/08	E23Series				554047	
		86/09~	E24Series			444132		
		95/01~	E24Series			444132		
VANETTE SERENA/SERENA								
		92/07~96/05	C23 (Made in Spain) Rear Multi LinK Suspension	R		334142		
				L		334143		
		92/07~	C23 (Made in Spain) Rear Rigid Axle	R		334142		
				L		334143		
		99/08~00/10	C24(2WD/4WD)	R		334421		343422
				L		334422		
		00/10~	C24(2WD/4WD)	R				343422
				L				
VIOLET/STANZA/AUSTER								
		77/07~81/07	KPA, PA, A10, 11 (Include OPEN BACK) (Except VAN)					553023
		77/07~81/07	VA10Series(VAN)					443070
X-TRAIL								
		01/10~	T30	R		334360		334362
				L		334361		334363

PROTON

製造商	車款	年份	規格	R	前		後	
					KYB No.		KYB No.	
					OIL	GAS	OIL	GAS
PROTON	PERSONA/SATRIA/300/400/COUPE							
		95/12~	C95, C98, C99	R				341140
				L				
	WIRA/PERSONA/SATRIA/300/400							
		95/12~	C96, C97	R		333224		341140
				L		333225		
	WIRA/PERSONA/SATRIA/400							
		93~95/11	C96, C97	R				341140
				L				
		93~95/11	C98	R		334072		341140
				L		334073		

SAMSUNG

製造商	車款	年份	規格	R	前		後	
					KYB No.		KYB No.	
					OIL	GAS	OIL	GAS
SAMSUNG								
	SM518/520/520V/525/525V							
		96~	KNMA	R		334480		341202
				L		334481		

SSANGYONG

製造商	車款	年份	規格	R	前		後	
					KYB No.		KYB No.	
					OIL	GAS	OIL	GAS
SSANGYONG								
	MUSSO							
		95/11~	661/661LA/662/662LA/E20/E23/E32 incl. H.Duty Sus. Chassis KPTE/F, KPDH			554146		554147

SUBARU

製造商	車款	年份	規格	R	前		後	
					KYB No.		KYB No.	
					OIL	GAS	OIL	GAS
SUBARU								
	FORESTER							
		97~02/01	SF5(2.0 4WD) without Self Leveling Suspension.	R		334189		334191
				L		334190		334192
		02/02~	SG5(2.0 4WD) without Self Leveling Suspension.	R		334342		334344
				L		334343		334345
		08/03~	SH#	R		339169		341486
				L		339170		
	IMPREZA							
		92/11~98/08	GC/GF1/3/5/7(2WD)	R	633187		634078	334146
				L	633188		634079	334147
		92~98/08	GC/GF3/5/7(2WD)	R		334113		334146
				L		334114		334147
		92~98/08	GC/GF3/5/7(2WD)	R		334113	634078	334146
				L		334114	634079	334147
		92~98/08	GC/GF4/6/8(4WD)	R		334113		334109
				L		334114		334110
		92~98/08	GC/GF8*L8(4WD;2.0Turbo)	R				334109
				L				334110
		98/08~00/08	GC/GF1/3/5/7(2WD)	R			634078	334146
				L			634079	334147
		98/08~00/08	GC/GF4/6/8(4WD)	R		334253		334109
				L		334254		334110

製造商	車款	年份	規格	R	前		後	
					KYB No.		KYB No.	
					OIL	GAS	OIL	GAS
		98/08~00/08	GC/GF8*L8(4WD;2.0Turbo GT/1.6GT)	R		334255		334109
				L		334256		334110
		00/09~02/10	GD9/A/E Sedan GX/RX(4WD, 2.0/2.0 Turbo/2.5) Excl.S Ti Version(GDB)	R				334306
				L				334307
		02/11~02/12	GD9/A/E Sedan GX/RX(4WD, 2.0/2.0 Turbo/2.5) Excl.S Ti Version(GDB) for Europe	R		334304		
				L		334305		
		04~	Outback TS for USA	R				334356
				L				
		05~07	Outback Sports, RS Wagon, 2.5I Wagon for USA	R				334356
				L				
			IMPREZA WRX					
		02/11~02/12	GG3/9/A Hatchback WRX/RS/TS(4WD, 1.6/2.0/2.0Turbo) Excl.S T i Version(GGB)	R				334356
				L				
		03/1~	GD9/A Sedan WRX(4WD.2.0/2.0Turbo) Excl. WRX-Sti Version(GDB) for Europe	R				334306
				L				334307
		03/01~	GG9/A Hatchback WRX (4WD 1.6/2.0/2.0Turbo) Excl. Sti Version(GGB) for Europe	R				334356
				L				
		05~07	WRX Wagon, WRX Limited Wagon for USA	R				334356
				L				
			JUSTY,J Series					
		96~	HSJ/N56(4WD) chassis No.TSMM***	R				333196
				L		333195		
			LEGACY					
		98/12~03/05	BE/BH5 Sedan/Estate, Excl.B4Sedan	R				
				L		334274		
			LEGACY/LIBERTY					
		91/07~93/12	BC, BF, BJ(2WD)	R			634078	334146
				L			634079	334147
		94/01~98/11	BD, BG(2WD)	R		334113		334164
				L		334114		334165
		91/07~93/12	BC, BF, BJ(4WD)	R				334109
				L				334110
		91/07~93/12	BC/BF5#L8 (4WD 2.0 Turbo)	R		334111		334109
				L		334112		334110
		94/01~96/05	BD/BG5, 7(4WD)	R		334113		
				L		334114		
		96/06~98/11	BD/BG5, 7(4WD)	R		334113		
				L		334114		
		96/06~98/11	BD/BG9#L9(4WD 2.5L)	R		334111		
				L		334112		

製造商	車款	年份	規格	R	前		後	
					KYB No.		KYB No.	
					OIL	GAS	OIL	GAS
CORONA								
		61~64	RT26G, 46G				443070	553249
		64~70/01	PT46V,47V,RT46,47V(VAN), PT46, 47(PICK-UP)				443070	553249
		73/08~78/08	RT106V,108V,TT106V(VAN)					553120
		78/09~81/12	TT130, 131, RT133 (13inch Tire)					343039 553041
		78/09~81/12	TT131, RT133, TT132, RT132 (14inch Tire)					343039 553041
		80~81/12	TT132					343039 553041
		82/01~86/12	AT140, ST140					343039 553041
		82/09~86/12	CT140 (Diesel)					343039 553041
CORONA/AVENSIS								
		97/10~02/12	AT220/221, ST220, CT220, ZZT220/221,AZT221, CDT220 (2WD Sedan/ Liftback /StationWagon) incl.made in U.K.	R		334203		334329
				L		334204		334330
CORONA/CARINA ε								
		92/03~97/11	AT190 1.6/1.8 Sedan/LB:5 Door HatchBack	R		333197		333107
				L		333198		333108
		92/03~97/11	AT190 1.6/1.8 Sedan/LB:5 Door HatchBack with Harsh Road Package	R		333197		333112
				L		333198		333113
		92/03~96/02	ST191 2.0 Sedan/LB:5Door Hatchback	R				334063
				L				334064
		92/03~98/05	ST191,CT190 2.0/2.0Diesel Sedan/LB:5Door HatchBack	R		334137		334063
				L		334138		334064
		96/02~98/05	ST191,CT190 2.0/2.0Diesel Sedan/LB:5Door HatchBack with Harsh Road Package	R		334137		334061
				L		334138		334062
		92/11~96/01	ST191 2.0 StationWagon	R		334137		334061
				L		334138		334062
		96/01~97/10	AT190, ST191,CT190 Sedan made in U.K.	R		334137		334061
				L		334138		334062
		92/02~96/01	AT190, ST191 (GX) for Japan Domestic	R		333197		
				L		333198		
CORONA/CARINA II								
		87/12~92/03	AT170, AT171	R				333063
				L				333064
		87/12~92/03	CT170	R				333063
				L				333064
CRESSIDA/MARK II/CHASER/CRESTA								
		68/09~71/12	RT6, 7Series				443070	553249
		72/01~76/12	RX26/27/28,MX27(WAGON)				443070	553249
		80/11~82/08	GX60 (WAGON)					343039 553041
		82/08~84/07	GX61X (WAGON)					343039 553041
CROWN								
		67/09~79/09	RS50/60, MS50/60/ 80Series(VAN, PICK-UP WAGON), MS66V, RS66V(VAN), MS87V				444012	
		95/08~99/08	GS151, JZS151/155, LS151			341262		
		00/01~03	JZS171			341266		341267

製造商	車款	年份	規格	R	前		後	
					KYB No.		KYB No.	
					OIL	GAS	OIL	GAS
DYNA								
		61~69	RK169/170Series, JK170Series			444024	344325 553248	444023
		69/02~70/05	RU10Series, JU10Series			444024	344325 553248	444023
		70/05~77/08	RU10/15, BU10, JU10/15 (Rear Double Tire)			444024	344325 553248	
		70/05~77/08	RU10/15, BU10, JU10/15 (Rear Single Tire), RU12Series, JU12Series, BU12			444024	344325 553248	444023
		77/08~84/11	JU20,BU20/21/22/23/25/31, RU20/30/32/33/34/35/36/ 37/45/46, HU30 (High Floor with Rear Double Tire)					444084
		80/08~84/08	BU35/36/40/41, 50, HU26D/40/50, WU25D					444023
		84/09~95/05	YU60/70, BU60/61/62 (Rear Single Tire) WU85/90					444084
		84/09~95/05	BU62H-MDDHT3, BU82			444203		444023
DYNA 150								
		85/08~87/08	YY61L, LY60L(LH Steering With Rear Double Tire)					553193
		87/08~95/05	YY61, LY60/61 (Rear Double Tire)					553193
		95/05~	YY211L,LY211L(LH Steering With Rear Double Tire)					553193
		01/07~	LY225/235 (Double Tire)					444109
HARRIER								
		97/12~03/02	ACU/MCU/SXU10(2WD)	R		334261		334269
				L		334262		334270
		97/12~03/02	ACU/MCU/SXU15(4WD)	R		334261		334263
				L		334262		334264
		03/02~	MCU## 3.0L, ACU## 2.4L (4WD) for Europe	R		334399		334394
				L		334400		334395
HI ACE								
		77/02~82/11	RH20G/22G/33G, LH20G/30G(WAGON)			444022	344332 553278	444084
		77/02~85/07	RH20/30/40Series, LH20/30/40Series(Single Tire), RH24, LH24(Double Tire)			444022	344332 553278	444023
		82/12~84/01	YH50/61/71, LH50/60/70 (Van with Single Tire)					444084
		82/12~84/01	YH61, LH60(Wagon Long with Rear Single Tire)					444023
		86/08~89/08	YH56V/66V, LH56V/66V (4WD Van)			344201		444123 344100 554118
		87/08~89/08	YH57G(Wagon)			344201		
		89/08~95/08	LH102/103/110/113/115/ 120/123/125 RZH102/103/112/113/115 (Van/Wagon/Commuter)			444104	344203 554136	444123 344100 554118
		89/08~95/08	LH100/101, RZH100/101(Wagon)				344203 554136	344100 554118
		93/08~95/08	KZH100/101G,LH100/101G, RZH100/101G for Mexico			444104	344203 554136	
		95/08~	RCH12/13/22/23,LXH12/22, KCH10/40, RCH41(2WD)				344203 554136	344484
		96/11~98/08	RZH135(Van/Commuter)				344203 554136	
		98/08~	RZH135(Van/Commuter)				344203 554136	
		96/11~	RZH153(Van/Commuter)				344203 554136	
		98/08~	LH154(Van/Commuter)			444104	344203 554136	

SUZUKI

製造商	車款	年份	規格	R	前		後	
					KYB No.		KYB No.	
					OIL	GAS	OIL	GAS
SUZUKI								
	BALENO/CULTUS CLESENT							
		95~01/11	SY41, GA(1.3/1.5/1.6/1.8 2WD, 1.6 4WD)	R		333312		333215
				L		333313		333216
		01/11~	SY41, GA(1.3/1.5/1.6/1.8 2WD, 1.6 4WD)	R		333312		333215
				L		333313		333216
	GRAND VITARA							
		06~	TA#, TD# 1.6L(3Door), 1.9DDIS(3/5Door), 2.0L(5Door)	R		334464		343435
				L		334465		
	GRAND VITARA XL-7/GRAND ESCUDO							
		01/07~	H27A 2.7V6 4WD WAGON, ALL MODELS	R		334195		344440
				L		334196		
	GRAND VITARA/GRAND ESCUDO/GRAND NOMADE							
		07~	For Chile	R		334464		
				L		334465		
	IGNIS/CHEVROLET CRUZE							
		00/10~	HR51/HV51/HX51(RG413) 1.3, 2WD	R		333346		342026
				L		333347		
		00/10~	HR51/HV51/HX51(RG413) 1.3, 4WD	R		333346		342027
				L		333347		
	LIANA/AERIO							
		01~03	RA21/RB21/RC31/RD51(R H41#) 1.3/1.5/1.6/1.8 2WD Sedan/5Door Hatchback	R		333354		333356
				L		333355		333357
		04~	SX/LX for USA	R		333431		333356
				L		333432		333357
	RB413/WAGON R PLUS							
		00/06~	MA53(1.3)	R		333306		343331
				L		333307		
	SE416/SV420/SV620/X-90/VITARA/ESCUDO							
		96~	TA0, TD0, TD1, TD3, TV0, TW0, LA1, LB1	R				343247
				L				553158
	SE416/VITARA/ESCUDO							
		88/05~95	TA0#, TD0#	R		334015		343247
				L		334016		553158
	SJ41#/JIMNY/SAMURAI/SANTANA/SIERRA/LJ series							
		98/12~	SN413:JA/B33			343287		343288
	SOLIO/WAGON R SOLIO							
		00/11~	MA34/63/64	R		333306		342027
				L		333307		
	SPLASH/RITZ							
		07/09~	1.0, 1.2, 1.3CDTi, Splash for Europe	R		333408		343420
				L		333409		
	SQ416/SQ420/SQ425/GRAND VITARA/ESCUDO							
		98~	TA0, TA5, TL5, TD3, TD6	R		334195		343247
				L		334196		553158
	SR410/SR412/WAGON R							
		96/07~	MA61, MA/B81	R		332092		
				L		332093		
	SUPER CARRY/EVERY							
		85/03~	SK410K/T; DA21/41/51/71/81	R		633060		
				L		633061		
		85/03~	SK410V; DA21/41/51/71/81	R		633060		
				L		633061		

製造商	車款	年份	規格	R	前		後	
					KYB No.		KYB No.	
					OIL	GAS	OIL	GAS
	SWIFT							
		05/05~	RS413 1.3i/RS415 1.5i for Europe	R		333408		343420
				L		333409		
		05~	RS413 1.3i/RS415 1.5i for Asia, China	R		333425		343464
				L		333426		
		05/04~	SC7132 for China	R		333425		343464
				L		333426		
	SWIFT/CULTUS/GEO METRO							
		88/09~90	AA34(SF413), AF/H35(SF413), AH/J14(SF416)	R				333196
				L				
		91~	AA/B44(SF310), AF/H/K35(SF413), AH/J14(SF416)	R				333196
				L		333195		

LEXUS

製造商	車款	年份	規格	R	前		後	
					KYB No.		KYB No.	
					OIL	GAS	OIL	GAS
LEXUS								
	ES							
		91/06~94/08	ES300 : SXV10, VC10			365085		365097
		91/06~94/08	ES300 : SXV10, VC10	R		334476		334478
				L		334477		334479
		94/08~96/08	ES300 : SXV10, VC10	R		334170		334478
				L		334171		334479
		94/04~96/08	ES300 : ##V10			365085		
		96/08~01/08	ES300 : MCV20/21, SXV20 3.0/2.2, Sedan 2WD	R		339086		334478
				L		339087		334479
		00/04~03/09	ES300 : MCX10 3.6 V6 Sedan	R		339086		334478
				L		339087		334479
		03/02~	ES300 : MCV30 3.0L (2WD) W/O Electronic Suspension	R		334386		334388
				L		334387		334389
		06/05~	ES350 : GSV40	R		339023		335059
				L		339024		335060
	GS							
		97/08~01/08	GS300 : JZS160/161			341266		341267
	IS							
		99/01~	IS200 : GXE10, SEX10			341262		341263
		02/09~	IS200/IS300 : GEX10W, JCE10W			341359		341360
		06~12	IS250 RWD	R		551130		551132
				L		551131		
		06~12	IS250/IS350 AWD	R		551126		551132
				L		551127		
		12~	IS250 RWD Sports sus.					551132

製造商	車款	年份	規格	R	前		後	
					KYB No.		KYB No.	
					OIL	GAS	OIL	GAS
	LS							
		89/11~94/09	LS400 : UCF10			341159		341268
		94/10~00/08	LS400 : UCF20			341159		341269
		00/08~06/06	LS430 : UCF30			341392		341393
		06/08~	LS460/460L:USF4#	R		551122		551123
				L				551124
	RX							
		97/12~03/02	RX300/RX330 : ACU/MCU/SXU10(2WD)	R		334261		334269
				L		334262		334270
		97/12~03/02	RX300/RX330 : ACU/MCU/SXU15(4WD)	R		334261		334263
				L		334262		334264
		03/02~06/01	RX300/RX330 : MCU3#, GSU35	R		334399		334394
				L		334400		334395
		06/01~07/05	RX300/RX350:GSU35	R		334399		334394
				L		334400		334395
		07/05~	RX300/RX350 : GSU35	R		334399		
				L		334400		
		09~10	RX350 AWD w/o Air Suspension	R		334399		
				L		334400		
		08~10	RX350 FWD w/o Air Suspension	R		334399		339208
				L		334400		339209
		10~	RX350 w/o Air Suspension, Exc. Sport Package	R		339281		349203
				L		339282		
		06~07	RX400H AWD	R		334399		
				L		334400		
		06~07	RX400H FWD	R		334399		
				L		334400		
		08~	RX400H AWD	R		334399		339208
				L		334400		339209
		08~	RX400H FWD	R		334399		
				L		334400		
	SC							
		91/05~01	SC300/SC400 : JZZ30, UZZ30			341161		341162

TOYOTA

製造商	車款	年份	規格	R	前		後	
					KYB No.		KYB No.	
					OIL	GAS	OIL	GAS
TOYOTA	4-RUNNER/HI LUX SURF							
		89/08~95/11	LN130, RN130, VZN130, YN130, 4WD Wagon			344202		
		02/11~	GRN210/215, KZN215, 4WD Wagon			341340		
	ALPHARD							
		08/04~	GGH20	R		335050		349002
				L		335051		
	ALTEZZA							
		99/01~	GXE10, SXE10			341262		341263
		02/09~	GXE10W, JCE10W			341359		341360

製造商	車款	年份	規格	R	前		後	
					KYB No.		KYB No.	
					OIL	GAS	OIL	GAS
	ARISTO							
		97/08~01/08	JZS160/161			341266		341267
	AURION							
		06/08~	GSV40 excluding Sports Model for Australia	R		339110		339112
				L		339111		339113
		06/08~	GSV40 for Sports Model for Australia	R		339106		339108
				L		339107		339109
	AVANZA							
		03/12~06	F601 All	R				343441
				L				
	bB/SCION xB							
		08~	2.4 GAS L4	R				349035
				L				
	CALDINA							
		96/01~01/12	AT210/211/212 1.6/1.8 Sedan	R		333197		
				L		333198		
		96/01~01/12	ST210, CT210 2.0/2.0 Diesel Sedan	R		334137		334063
				L		334138		334064
		99/12~02/09	ST215G/W (2.0/2.0Turbo 4WD GT/GTT)	R		334137		
				L		334138		
	CAMRY							
		02/09~	ACV36/MCV36(MT) for Australia	R		334424		334426
				L		334425		334427
		06/01~	ACV40	R		339023		339025
				L		339024		339026
		06/08~	ACV4# for Asia	R		339110		339112
				L		339111		339113
	CAMRY GRACIA							
		97/06~99/09	MCV25, SXV25 4WD, Sedan/Wagon	R		334348		334296
				L		334349		334297
		97~	MCV21/22W, SXV20/20W	R		339086		334478
				L		339087		334479
		01/10~	AVC30 2.4L/MCV30 3.0L	R		334338		334340
				L		334339		334341
	CAMRY/MSTA							
		80/01~82/02	TA41(1600)					343039
								553041
		86/08~91/06	SV2#(2WD Sedan/Station Wagon)	R		334067		334065
				L				334066
		90/07~94/06	CV30 (Diesel)					365097
				R				334296
		92/07~94/06	SV35 (4WD)					334297
				L				365097
		94/06~98/06	SV40, SV41, SV42, CV40					334170
				R		334170		334478
		94/06~98/06	SV40, SV41, SV42, CV40			334171		334479
				L				334296
		94/06~98/06	C/SV43 (4WD)					334297
				L				
	CARINA							
		77/08~81/09	TA4Series, RA4Series					343039
								553041
		81/09~85/08	AA60 (1800COUPE), SA60 (1600COUPE)					343039
								553041
		82/02~85/08	SA60G (Wagon)					343039
								553041
	CELICA							
		93/09~98/01	ST200, ST202, ST203, ST204	R		365092		334125
				L				334126
		98/01~99/07	ST200, ST202, ST203, ST204	R		334378		334125
				L		334379		334126
		94/02~99/08	ST205 (4WD;GT-FOUR) with Front Toyota Super Strut Suspension	R		331018		334127
				L		331019		334128
		99/08~04/06	ZZT231 for General Export Model (except Canada, USA, Europe)	R		334277		341278
				L		334278		
		99/08~00/08	ZZT230/1 for Canada, USA	R		334277		341277
				L		334278		
		99/08~99/10	ZZT230 for Europe	R		334277		341277
				L		334278		
		99/10~00/08	ZZT230 for Europe	R		334277		341278
				L		334278		

製造商	車款	年份	規格	R	前		後	
					KYB No.		KYB No.	
					OIL	GAS	OIL	GAS
	HI LUX							
		68~78/08	RN10,13,15,16,20,22,23,25				444026	553249
		78/09~80/08	RN30/32/33/35/40(2WD)			343345	444026	553249
		79/12~84/03	LN30/40/41(2WD)			343345	444026	553249
		81/10~88/09	RN35/45, LN41			343345	444026	553249
		83/08~98/07	LN/YN50Series (2WD)			443214		343199
		85/08~98/07	LN61V, YN61V (4WD, VAN;SURF)			444103	344202	
		88/08~97/08	LN/YN85 (2WD, Double-Cabin)			443214		343199
		88/08~97/02	LN/YN85 (2WD, Single-Cabin)			443214		
		88/08~91/10	LN90, YN90(2WD)			443214	443258	553189
		88/08~97/08	RN106/135, LN/YN/ RN107/110, LN108(4WD)			444103	344202	
		97/08~	LN145, LN150, RZN152			443214		
		97/08~	LN145(Double-Cabin), LN/RZN147			443214		
		97/08~	LN165/170, RZN168/173	R				343299
				L		344202		343300
	HI LUX FORTUNER							
		05/08~	KUN50, TGN51			341372		
	HI LUX VIGO							
		04/08~	GGN15, KUN1#, TGN1#	R				349023
				L				
		04/08~	GGN25, LKUN2#/3#, TGN26/36			341372		
		05/01~	KUN2#/3#, TGN26/36 for Latin America (exc. Ecuador/Colombia)			341372		
	HIGHLANDER/KLUGER							
		02~	MCU## 3.0L, ACU## 2.4L(FWD/AWD) for USA	R		334399		
				L		334400		
		01~03	MCU## 3.0L, ACC## 2.4L(FWD/AWD) for USA	R		334399		
				L		334400		
		04~	ACU## 2.4L (FWD/AWD) for USA	R		334399		334394
				L		334400		334395
	INNOVA/KIJANG							
		04/08~	KUN40, TGN40/41	R				349016
				L				
	LAND CRUISER							
		69/03~75/01	FJ40/40V, BJ40/40V			444024	344325 553248	444026 553249
		75/01~88/08	FJ40/40V, BJ40/40V, FJ43, BJ43/44, FJ45			444024	344325 553248	444012 553257
		69/03~80/08	FJ55/56V					444012 553257
		80/08~84/11	BJ60/61, HJ60, FJ60/61					444012
		84/11~85/10	BJ60, HJ60, FJ60/62 (WGV;Van Type)					444012
		84/11~85/10	HJ60,61, FJ60/62 (WGG;G Type)					444012
		90/01~96/04	HZJ70/73, PJZ70/73					344212
	LAND CRUISER PRADO							
		02/09~	GRJ/KZJ/LJ/RZ125(4WD)			341340		
	LITE ACE							
		79/10~85/09	KM20, TM20, CM20, YM21(WAGON/VAN with Rear Double Tire)			443181	553285	553116
		79/10~85/09	KM20, CM20, YM20(VAN with Rear Single Tire)			443181	553285	
		79/10~85/09	KM21, CM20/25, YM20/25			443181	553285	
	OPA							
		04/01~05/04	ACT1#, ZCT1#					341321
	PREMIO/ALLION							
		01/12~07/10	NZT240, ZTZ240 (2WD) 1.5L/1.8L VVT-I for Right Hand Vehicle	R				341321
				L				
		01/12~07/10	AZT240 (2WD) 2.0L VVT-I for Right Hand Vehicle	R		334323		341321
				L		334324		
		07/10~	NZT260	R				341321
				L				

製造商	車款	年份	規格	R	前		後	
					KYB No.		KYB No.	
					OIL	GAS	OIL	GAS
	PREVIA/TARAGO							
		06/01~	ACR50	R		335050		349002
				L		335051		
		06/11~	GSR50	R		335050		349002
				L		335051		
	PREVIA/TARAGO/ESTIMA							
		00/03~03/04	ACR30,CLR30,MCR30 (2WD)	R		334284		344308
				L		334285		
		03/04~	ACR30, CLR30	R		334284		344308
				L		334285		
		00/03~	ACR40, MCR40 (4WD)	R				344480
				L				
	PREVIA/TARAGO/ESTIMA/LUCIDA/EMINA							
		90/05~99/12	TCR11 (2WD),TCR21 (4WD) (Rear;Independent axle)	R		334093		344225
				L		334094		
		90/05~99/12	TCR/CXR10 (2WD), TCR20 (4WD) (Rear;Rigid axle)	R		334093		344226
				L		334094		
	PRIUS							
		00/08~03/08	NHW10/11 Hybrid Motor Vehicle, Sedan	R		333360		341321
				L		333361		
		03/08~03/11	NHW20 Hybrid Motor Vehicle, Sedan	R		333388		341363
				L		333389		
		03/11~	NHW20 Hybrid Motor Vehicle, Sedan	R				341382
				L				
		04~09	NHW20	R		333388		341322
				L		333389		
		05/11~	NHW20 for China	R		333388		341363
				L		333389		
		09/01~12/99	ZVW30	R		339242		349035
				L		339243		
	PROBOX / SUCCEED							
		02/06~	NCP50/51/52/58, NLP51 Van/Wagon			333407		
	RAUM							
		97/05~00	EXZ10	R		333209		341191
				L		333210		551064
	RAV-4							
		94/04~98/01	SXA10G, SXA11G, SXA15G, SXA16G			365093		343272
		98/01~00/04	SXA10G, SXA11G, SXA15G, SXA16G except 235/60-16 Tire	R		334482		343272
				L		334483		
		96/08~00/04	SXA10G(3 Door) with 235/60-16 Tire	R		334482		
				L		334483		
		00/05~	ACA20/21 (2.0, 3/5 Door), ZCA25/26 (1.8, 3/5 Door)	R				343272
				L				
		00/05~	ACA21 (2.0, 5 Door), ZCA26(1.8,5Door) for Europe	R				343272
				L				
		01/05~	CLA20 (2.0TD, 3 Door)	R				343272
				L				
		01/05~	CLA21 (2.0TD, 5 Door)	R				343272
				L				
		04~	ACA#, ZCA# for USA					343272
		06/01~	ACA30, ALA30 for Europe ACA33/38,GSA33/38 for USA	R		339031		349024
				L		339032		
	RUSH							
		06/05~	J2##					343441
	SIENNA							
		03/01~05/07	MCL20/23 CE, LE, XLE type Wagon 3.3L for USA, Canada & Mexico	R				344308
				L				
		04/03~05/03	MCL20/25 LE, XLE type Wagon 3.3L for USA, Canada	R				344480
				L				
		05/03~05/07	MCL20/25 LE, XLE type Wagon 3.3L for USA, Canada	R		334452		344480
				L		334453		
		07~10	FWD exc. 8 passenger seating for USA	R				344308
				L				
		07~10	AWD/FWD for 8 passenger seating for USA	R				344480
				L				

製造商	車款	年份	規格	R	前		後	
					KYB No.		KYB No.	
					OIL	GAS	OIL	GAS
CELICA/SUPRA								
		77/10~80/07	RA40/45/46, MA40/45/46, TA40 (14inch Tire)					343039 553041
		77/10~80/07	RA45, TA45/46/47 (13inch Tire)					343039 553041
		81/08~85/07	SA60, TA60 (Rear Rigid Axle)					343039 553041
		81/08~85/07	RA60/64 (Rear Rigid Axle)					343039 553041
CELSIOR								
		89/11~94/09	UCF10			341159		341268
		94/10~00/08	UCF20			341159		341269
		00/08~06/06	UCF30			341392		341393
COASTER								
		69/02~72/01	RU18, JU18		444024	344325 553248	444023	
		72/01~77/07	RU19, BU19		444024	344325 553248		
		93/01~01/08	BB40/50, HZB50, RZB40/50				444178	
		01/08~	BB42/5#, BZB40/50, HZB50, RZB40/50				444178	
		04/03~	RZB53, BB53			345057		344212
		04/03~	RZB54, BB54					344212
COROLLA								
		00/08~	NZE121;Sedan/Station Wagon without Rough Road Package, Bult in Japan	R				341322
				L				
		00/08~02/09	NZE120, NZE121 LX, ZZE121 LHD, ZZE122, CE120 Sedan/Station Wagon without Rough Road Package, Bult in Japan	R				341322
				L				
		00/08~02/09	ZZE121, CE120, Sedan/Station Wagon with ABS, without Rough Road Package, Bult in Japan	R		334323		341322
				L		334324		
		02/09~	NZE120, NZE121 LX, ZZE121/122, CE120 Sedan/Station Wagon without Rough Road Package, Bult in Japan, except Philippine & Vietnam	R		334323		341322
				L		334324		
		00/08~	NZE120, NZE121 LX, ZZE121/122 Sedan/Station Wagon with Rough Road Package, Bult in Japan, except Philippine & Vietnam	R		334323		341322
				L		334324		
		01/10~	ZZE122;5DoorHB, ZZE122; Sedan for Australia, Bult in Japan	R				341338
				L				
		01/11~	ZZE120/121/123, CDE120 exc. Rough Road Package Made in Turkey for Europe	R				341338
				L				
		02/01~	ZZE120/121, CDE120 Made in Turkey for Europe	R				341338
				L				
		02/08~	ZZE120/121/122/123	R		334376		341338
				L		334377		
		02/09~04/04	CE120, ZZE121/122 with ABS for General Countries	R				341322
				L				
		04/04~	CE120, NZE120/121, ZZE120/121/122 without ABS for General Countries	R				341322
				L				
		04/04~	ZZE122 for Australia	R				341338
				L				
		06~	CE, LE, SSseries (excluding Japan Built)	R		334450		341382
				L		334451		

製造商	車款	年份	規格	R	前		後	
					KYB No.		KYB No.	
					OIL	GAS	OIL	GAS
COROLLA SEDAN/COROLLA HATCHBACK/AURIS								
		07/03~	ZRE152	R				349035
				L				
COROLLA SEDAN/COROLLA WAGON/COROLLA AXIO/COROLLA FIELDER								
		07/04~	CE140, NZE141, ZZE14# Sedan	R		339114		
				L		339115		
		07/08~	ZZE14#, CE140, NZE141 LX, XLI for Rough Road Area	R				341338
				L				
		07/08~	ZZE14#, CE140, NZE141 LX, XLI for Rough Road Area	R				341363
				L				
COROLLA/COROLLA ALTIS(ASIA/INDIA)								
		01/03~	ZZE121 (1.6), ZZE122 (1.8) Sedan	R		333338		341307
				L		333339		
		01/05~	ZZE121 (1.6), ZZE122 (1.8) Sedan	R				341307
				L				
		01/07~	NZE12#, ZZE12# for Asean	R		334323		341322
				L		334324		
		08/08~11/04	ZZE142 for India	R				341363
				L				
		11/05~	NDE140 for India	R				341363
				L				
COROLLA/SPRINTER								
		83/05~85/05	AE80/81/82, EE80	R				332011
				L				332012
		83/05~85/05	CE80	R				332011
				L				332012
		85/05~87/04	EE80, AE80, AE82 (Except GT)	R				332011
				L				332012
		85/05~87/04	CE80	R				332011
				L				332012
		87/05~92/05	EE90, AE91/92	R		333118		333051
				L		333119		333052
		87/05~91/05	EE90, AE91	R		333118		
				L		333119		
		87/05~92/05	AE92 (1600GTi)	R				333051
				L				333052
		87/05~92/05	CE90 (1800Diesel)	R				333051
				L				333052
		87/05~92/05	EE90, AE91/92, CE90 with Rough Road Package	R				333051
				L				333052
		87/08~91/09	EE96/97/98 (2WD Van/Wagon)	R		333118		343039
				L		333119		553041
		87/08~91/09	CE96/97 (2WD Diesel Van/Wagon)					343039 553041
		91/06~95/05	EE100, AE100	R		333114		
				L		333115		
		92/05~97/04	EE100/101, AE100/101	R		333114		333116
				L		333115		333117
		92/05~97/04	CE100	R				333116
				L				333117
		92/05~97/04	EE100, CE100 with Rough Road Package	R				333116
				L				333117
		91/09~00/08	EE106V/107V/108G (2WD Van/Wagon)	R		333114		343039
				L		333115		553041
		91/09~00/08	CE106V/108G (2WD Van/Wagon)					343039 553041
		95/05~00/08	EE110/111, AE110/111	R		333236		
				L		333237		
		97/05~00/08	EE111, AE111/112	R		333236		334178
				L		333237		334179
COROLLA/SPRINTER CARIB/SPACIO								
		97/05~00/08	AE111, CE110, CE111	R		334176		334178
				L		334177		334179
		97/10~98/10	AE11#, CE110, EE110 for General	R				333116
				L				333117

製造商	車款	年份	規格	R	前		後	
					KYB No.		KYB No.	
					OIL	GAS	OIL	GAS
		11~12	FWD 3.5L for USA	R				344308
		11~12	AWD/FWD 2.7L for USA	R				344480
	SOARER	86/01~91/04	GZ20, MZ20/21			341069		341070
		91/05~01	JZZ30, UZZ30			341161		341162
	STARLET	94/05~96/01	EP80, EP81, EP82, NP80	R				341191
				L				551064
		96/01~00	EP91	R		333209		341191
				L		333210		551064
	STOUT/LIGHT STOUT	50~60	RK21, 22, 23, 24, 25, RK30, 31, 32, 33, 34, 35				444012	
		60~66	RK45, 45V, 45P, 45B, RK100				444026	
		63~68	RK40, 40V(VAN), 43				444026	553249
		79/03~	RK110, RK111				444023	
	SUPRA	86/01~93/05	GA70, MA70, JZA70			341069		341070
		93/05~96/01	JZA80			551069		551070
	T.U.V (CONDOR/KIJANG/QUALIS/REVO/TAMARAW FX/ZACE)	96/12~	KF70/72/80/82, LF60/72/80, RZF71/81/82 (1.8/2.0/2.5D Transpotation Utility Vehicle)		443181	553285	443258	553189
		96/12~	KF60 RHDive, LF60 RHDive		443181	553285		
		99/02~	KF60 LHDive		443181	553285		
		00~	RZF80R(2WD) for Eastern & Southern Africa		443181	553285	443258	553189
		00~	RZF80R(4WD) for Eastern & Southern Africa				443258	553189
		99/11~	RZF84/85 LHDive				443258	553189
		02/10~	KF80 GL for Taiwan, KF82 GL for Vietnam		443181	553285		
	TACOMA	95/01~	RZN1##, VZN1## (4WD Truck)			551083		554131
		05~	V6 4.0L, L4 2.7L(4WD Regular Cab) including PRE RUNNER for North America			341340		
		05~	L4 2.7L (4WD) STD. Cab for North America			341340		349010
		05~	V6 4.0L, L4 2.7L (RWD) including PRE RUNNER for North America					349010
	TAMARAW/KIJANG/ZACE/QUALIS	91~	KF50, KF51, CF50		443181	553285		
		99~03	LF50, RZF50		443181	553285		
	TERCEL/PASEO/CORSA	90/09~95/08	EL4#, NL4#					341125
		95/08~99	EL5#	R		333209		341191
				L		333210		551064
	TOWN ACE/MODEL F/SPACE CRUISER	76/10~82/10	KR10, TR11, TR15(VAN/WAGON)				443089	553248
	TOYO ACE	56~71	RK30, 30P, 30V(VAN), 32, 32P, 32V(VAN), 41, 42				444023	
		71/09~79/02	JY16, RY16(ZT) (2T)		443070	553249	444023	
		79/03~82/08	JY30(Single Tire)				444084	
		80/09~85/07	BY30, JY30				444084	

製造商	車款	年份	規格	R	前		後	
					KYB No.		KYB No.	
					OIL	GAS	OIL	GAS
	VIOS/SOLUNA VIOS	02/10~	AXP4#					343354
		02/12~	NCP42 ATM 15S					343400
		02/12~	NCP4#(13E, 13STD, 15E, 15G, 15J)					343400
		03/03~07/09	NCP42 for Taiwan(15G)					343354
		03/05~	NCP42 for Asia					343354
	VISTA/VISTA ARDEO	98/07~03/10	SV50, ZZV50	R				341321
				L				
	WINDOM/CAMRY/AVALON/SCEPTER/MIENTA	91/06~94/08	SXV10, VCV10			365085		365097
		91/06~94/08	SXV10, VCV10	R		334476		334478
				L		334477		334479
		94/08~96/08	SXV10, VCV10	R		334170		334478
				L		334171		334479
		94/04~96/08	##V10			365085		
		96/08~01/08	MCV20/21, SXV20 3.0/2.2, Sedan 2WD	R		339086		334478
				L		339087		334479
		00/04~03/09	MCX10 3.6 V6 Sedan	R		339086		334478
				L		339087		334479
		03/02~	MCV30 3.0L(2WD) W/O Electronic Suspension	R		334386		334388
				L		334387		334389
	WISH	03/12~	ANE1#	R		339005		341389
				L		339006		
		04/09~	ZNE1#	R		334436		341375
				L		334437		
	YARIS VERSO/FUN CARGO	99/08~	NCP20(2WD) With Rear Disk Brake					343317
	YARIS/VITZ	05/08~	NCP9# All excluding for Asia	R		334472		343442
				L		334473		
		05/08~	NCP91 for Canada, USA and Mexico	R		334472		343442
				L		334473		
	YARIS/BELTA	05~12	KSP/SCP/NCP9#					343442
	YARIS/VITZ/ECHO/PLATZ	99/08~02/05	NCP, SCP ALL			333258		343295
		02/05~	NCP, SCP ALL					343295

AUDI

製造商	車款	年份	規格	R L	前		後	
					KYB No.		KYB No.	
					OIL	GAS	OIL	GAS
AUDI								
	Audi 80/90, 80 Variant/ Avant[78~91]	9/78~86	80 All ( 81 ) ( exc. Quattro )			365500	341003	
		9/83~8/86	80 Quattro ( 81 ) ( exc. Sport Sus. )			365500	366006	
		9/84~12/86	90 Quattro ( 81 ) ( exc. Sport Sus. )			365500	366006	
		10/84~86	90 All ( 81 ) ( exc. Quattro )			365500	341003	
		9/86~8/91	80 Quattro ( 89, 8A ) ( exc. Sport Sus., 2.3, 2.3 20V )			365500	366006	
		10/86~8/91	80 All ( 89, 8A ) ( exc. Quattro, Sport Sus., 2.3, 2.3 20V )			365500	341003	
		1/87~8/91	90 Quattro ( 89, 8A ) ( exc. Sport Sus., 2.3, 2.3 20V )			365500	366006	
		87~8/91	90 All ( 89, 8A ) ( exc. Quattro, Sport Sus., 2.3, 2.3 20V )			365500	341003	
	Audi 80 , Variant / Avant[91~95]	9/91~95	80 ( 8C, B4 ) 1.6, 1.9TD, 1.9TDi, 2.0, 2.0E, 2.3E, 2.6E, 2.8E, ( exc. Sport Sus., Quattro, Bad Road Sus. )			365500	341130	
		9/91~95	80 ( 8C, B4 ) w/ Sport Sus., All. ( exc. Quattro )			365500	341132	
		9/91~95	80 ( 8C, B4 ) Quattro ( exc. SR, RS2 )			365500		
	Audi 100, 100 Avant	76~8/82	All ( 32, C2 )			366002		
		9/82~90	All ( 44, C3 ) ( exc. Quattro )			366002	341016	
		10/84~94	All Quattro ( 4A, C4 ) ( exc. Sport Sus., S4 , Bad Road Sus. )			366002	341205	
		10/84~94	All Quattro ( 4A, C4 ) ( exc. S4 )			366002	341206	
		12/90~94	All ( 4A, C4 ) w/ Sport Sus ( exc. Quattro , S4, Bad Road Sus. )			366002	341133	
	Audi 200, 200 Avant	80~8/83	All ( 43, C2 )			366002		
		86~90	All Quattro ( 44, C3 ) ( exc. Sport Sus., 2.2 Turbo )			366002	341205	
		86~90	Quattro ( 44, C3 ) , 2.2 Turbo w/ Sport Sus.			366002	341206	
	9/83~90	All ( 44, C3 ) ( exc. Quattro )			366002	341016		
	Audi A1 ( 8X1 ), A1 Sportback ( 8XA )	5/10~	1.2 TFSi , 1.4 TFSi, 1.6 TDi , 2.0 TDi ( 8X1, 8XA ) ( w/ Bad Road Sus., H/D Sus. )				343348	
	Audi A3 ( 8L1 )	9/96~7/99	2WD All w/ Sport Sus. ( 8L1 )			334812		
		9/96~7/99	Quattro All ( 8L1 ) , W/ Sport Sus. ( exc. S3 )			334812		
		9/96~7/99	Quattro All ( 8L1 ) ( exc. Sport Sus. S3 )			334812	343310	
		9/96~7/99	Quattro All ( 8L1 ) , w/ Bad Road Sus ( exc. S3 )			334812	344301	
		8/99~4/03	2WD 1.6, 1.8, 1.8 Turbo, 1.9 TDi ( 8L1 ) ( exc. Sport Sus. )			334812	343348	
		8/99~4/03	2WD All w/ Sport Sus. ( 8L1 )			334812		
	Audi A3 ( 8P )	5/03~	2WD , 1.2 TDi, 1.2 TFSi, 1.4 TFSi, 1.6i, 1.6Fsi, 1.6 TDi, 1.6 Epower, 1.8 TFSi, 1.9 TDi, 2.0 FSi, 2.0 TDi, 2.0 TFSi ( 8P ) ( exc. Sport Sus., Bad Road Sus., Quattro )			334834(1) 335808(2)	344459	
		5/03~	4WD 3 door, 2.0 TDi Quattro( 8P ) ( exc. Sport Sus., Bad Road Sus. )			335808	344459	
		7/03~	4WD 3 door, 3.2 V6 Quattro( 8P ) ( exc. Sport Sus., Bad Road Sus. )			335808	344459	
		9/04~	4WD 3 door, 2.0 TFSi Quattro( 8P ) ( exc. Sport Sus., Bad Road Sus. )			335808	344459	
		7/08~	4WD 3 door, 1.8 TFSi Quattro( 8P ) ( exc. Sport Sus., Bad Road Sus. )			335808	344459	

製造商	車款	年份	規格	R L	前		後	
					KYB No.		KYB No.	
					OIL	GAS	OIL	GAS
	Audi A3 Sportback ( 8P )	9/04~	2WDD 5 Door All ( 8P ) ( exc. Sport Sus., Bad Road Sus., Quattro )			334834(1) 335808(2)	344459	
		9/04~	4WD 5 door, 2.0 TFSi Quattro, 3.2 V6 Quattro( 8P ) ( exc. Sport Sus., Bad Road Sus. )			335808	344459	
		11/05~	4WD 5 door, 2.0 TDi Quattro( 8P ) ( exc. Sport Sus., Bad Road Sus. )			335808	344459	
		7/08~	4WD 5 door, 1.8 TFSi Quattro( 8P ) ( exc. Sport Sus., Bad Road Sus. )			335808	344459	
	Audi A4 ( 8D ) , A4 Avant ( 8D )	11/94~1/99	2 or 4 Door Saloon, Estate, All 2WD ( 8D, B5 ) ( exc. Sport Sus. )			341842	343271	
		11/94~1/99	2 or 4 Door Saloon, Estate, All 2WD ( 8D, B5 ) w/ Sport Sus.				343271	
		11/94~1/99	2 or 4 Door Saloon, Estate, All 4WD ( 8D, B5 ) ( exc. Sport Sus., S4 )			341842	341909	
		2/99~11/00	2 or 4 Door Saloon, All 2WD ( 8D, B5 ) ( exc. Sport Sus., Bad Road Sus. )			341842	343302	
		2/99~11/00	2 or 4 Door Saloon, All 2WD ( 8D, B5 ) w/ Sport Sus.				343302	
		2/99~11/00	2 or 4 Door Saloon, All 4WD ( 8D, B5 ) ( exc., Sport Sus., S4 )			341842	341909	
		2/99~9/01	Estate All 2WD ( 8D, B5 ) ( exc. Sport Sus., Bad Road Sus. )			341842	343302	
		2/99~9/01	Estate All 2WD ( 8D, B5 ) w/ Sport Sus.				343302	
		2/99~9/01	Estate All 4WD ( 8D, B5 ) ( exc. Sport Sus., S4 )			341842	341909	
	Audi A4 ( 8E )( 8H )	11/00~11/04	All 2WD w/ Sport Sus., ( 8E, B6 ) ( exc. Bad Road Sus., S4 )			341845	341814	
		4/02~3/09	Cabriolet, Convertible All 2WD, 4WD ( 8H, B7 ) ( exc. S4, RS4 )			341845	341814	
		11/04~3/08	All 2WD ( 8E, B7 ) ( exc. Sport Sus. )			341845	344807	
		11/04~3/08	All 2WD w/ Sport Sus., ( 8E, B7 )				344808	
		11/04~6/08	All 4WD ( 8E, B7 ) ( exc. Sport Sus., Bad Road Sus., S4, RS4 )			341845	344807	
		11/04~6/08	All 4WD w/ Sport Sus., ( 8E, B7 ) ( exc. Bad Road Sus., S4, RS4 )				344808	
	Audi A6 ( 4B )	97~ 04	1.8i, 1.8T, 1.9TDi , 2.4i V6, 2.8i V6, 3.0i V6, Chassis No. 4B#X#070000 ( 4B, C5 ) ( exc. Sport Sus., Quattro, S6, Bad Road Sus. )			341842	343281	
		97~ 04	1.8i, 1.8T, 1.9TDi , 2.4i V6, 2.8i V6, 3.0i V6, Chassis No. 4B#X#070000--> 4B#Y#200000 ( 4B, C5 ) ( exc. Sport Sus., Quattro, S6, Bad Road Sus. )			341843	343281	
		97~ 04	1.8i, 1.8T, 1.9TDi , 2.5 TDi , 2.0i, 2.4i V6, 2.8i V6, 3.0i V6, Chassis No. 4B#1#000001 ( 4B, C5 ) ( exc. Sport Sus., Quattro, S6, Bad Road Sus. )			341844	343281	
		97~ 04	Quattro w/ Sport Sus. 1.8i, 1.8T, 1.9TDi , 2.4i V6, 2.5TDi, 2.7 T V6 , 2.8i V6, Chassis No. 4B#Y#200000 ( 4B, C5 ) ( exc. S6, Bad Road Sus. )			341843		
		97~ 04	Quattro w/ Sport Sus., 1.8i, 1.8T, 1.9TDi , 2.0i, 2.4i V6, 2.7 T V6 , 2.8i V6, 3.0i V6 , Chassis No. 4B#1#000001 ( 4B, C5 ) ( exc. S6, Bad Road Sus. )			341844		
		97~ 04	Quattro 1.8i, 1.8T, 1.9TDi , 2.0i, 2.4i V6, 2.5TDi, 2.7 T V6 , 2.8i V6, 3.0i V6, Chassis No. 4B#2#000001( 4B, C5 ) ( exc. Sport Sus., S6, Bad Road Sus. )			341844		
		97~ 04	Quattro 1.8i, 1.8T, 1.9TDi , 2.4i V6, 2.5TDi, 2.8i V6, Chassis No. 4B#X#070000( 4B, C5 ) ( exc. Sport Sus., S6, Bad Road Sus. )			341842		
		97~ 04	Quattro 1.8i, 1.8T, 1.9TDi , 2.4i V6, 2.5TDi, 2.8i V6, Chassis No. 4B#X#0700011--> 4B#Y#200000( 4B, C5 ) ( exc. Sport Sus., S6, Bad Road Sus. )			341843		
		97~ 04	Quattro 1.8i, 1.8T, 1.9TDi , 2.4i V6, 2.5TDi, 2.7 T V6 , 2.8i V6, 3.0i V6, Chassis No. 4B#1#000001--> 4B#1#200000( 4B, C5 ) ( exc. Sport Sus., S6, Bad Road Sus. )			341844		

製造商	車款	年份	規格	R L	前		後	
					KYB No.		KYB No.	
					OIL	GAS	OIL	GAS
	Audi A6 (4B)	97~04	w/ Bad road Sus., 1.8i, 1.8Turbo, 1.9 TDi, 2.5TDi, 2.0, 2.4 V6, 2.7 Turbo V6, 2.8 V6, 3.0V6, Chassis No. 4B#1#000001 (4B, C5) (exc. Quattro, Airspring Sus.)			341301		345027
	Audi A6, A6 Avant	6/94~12/97	2 or 4 Door Saloon, Estate, All 2WD w/ Sport Sus (exc. Bad Road Sus., S6)			366002		341133
6/94~12/97		2 or 4 Door Saloon, Estate, All 4WD (exc. Sport Sus., Bad Road Sus., S6)			366002		341205	
6/94~12/97		2 or 4 Door Saloon, Estate, All 4WD w/ Sport Sus (exc. S6)			366002		341206	
	Audi Cabrio	6/91~8/00	All (8G7, B4)			365500		341912
	Audi Coupe	8/81~9/88	GT, 1.8, 1.9, 2.0L			365500		341003
		8/83~9/88	GT5E, 1.8, 1.9, 2.0L			365500		341003
		9/84~9/88	All 4WD (85) (exc. Sport Sus.,)			365500		366006
		10/88~12/96	All 2WD Inc Sport Sus.( 89)			365500		341153
		10/88~12/96	All 4WD (89) (exc. S2)			365500		366008
	Audi TT Roadster (8N9)	10/98~3/07	2WD 1.8T (8N9) (exc. Sport Sus.)					343348
	Audi V8	88~94	3.6 V8			366002		341206
		91~94	4.2 V8			366002		341206

BMW

製造商	車款	年份	規格	R L	前		後	
					KYB No.		KYB No.	
					OIL	GAS	OIL	GAS
BMW								
	BMW 1 Series (E81, E87) 3 & 5 Door Hatchback	9/04~9/12	116i, 118i, 120i, 130i, 116d, 118d, 120d, 123d, (exc. Sport Sus.)	R L		334625 334626		349041
	BMW 1 Series (E82) Coupe	10/07~	120i, 125i, 135i, 118d, 120d, 123d (exc. Sport Sus.)	R L		334625 334626		349041
	BMW 1 Series (E88) Cabriolet, Convertible	3/08~	118i, 120i, 125i, 135i, 118d, 120d, 123d (exc. Sport Sus.)	R L		334625 334626		349041
	BMW 3 Series (E30) 2& 4 Door Saloon / Coupe	82~12/90	316/ 316i Sport, 318i / 318iS Sport, 320i Sport, 324d Sport (E30) 320iS, 323i, 324td, 325e, 325i w/ Sport (exc. 4WD 325iX)			364021		343184
		82~12/90	316, 316i, 318i, 318iS, 324d (E30) (exc. Sport)			363500		343184
		82~9/87	320i (E30) (exc. Sport)			363500		343184
		10/87~12/90	320i (E30) (exc. Sport)			363500		343184
	BMW 3 Series (E30) Touring Estate	88~2/94	320i, 324td, 325i (E30) w/ Sport (exc. 4WD 325iX)			364021		343184
		3/89~9/89	316i, 318i (E30) (exc. Sport)			363500		343184
		10/89~2/94	316i, 318i (E30) (exc. Sport)			364021		343184
		3/89~2/94	316i Sport, 318i Sport (E30)			364021		343184
	BMW 3 Series (E30) Cabriolet, Convertible	85~2/93	318i, 320i, 325i (E30) w/ Sport (exc. 4WD, 325iX)			364021		343184
	BMW 3 Series (E36) 2 & 4 Door Saloon, Coupe	90~8/91	316i, 318i (E36) (exc. M~Technik Sus., M3)	R L		333915 333916		343255
		90~8/91	320i, 325i, 325td (E36) (exc. M~Technik Sus., M3)	R L		334923 334924		343255
		9/91~5/92	316i, 318i, 318iS (E36) (exc. M~Technik Sus., M3)	R L		333917 333918		343255
		9/91~5/92	320i, 325i, 325td (E36) (exc. M~Technik Sus., M3)	R L		334925 334926		343255
		6/92~6/98	316i, 318i, 318tds, 318iS (E36) (exc. M~Technik Sus., M3) (exc. East European Spec)	R L		333909 333910		343255
		6/92~6/98	East European spec 316i, 318i, 318iS, 318tds (E36) (exc. M~Technik Sus., M3)					343255

製造商	車款	年份	規格	R L	前		後	
					KYB No.		KYB No.	
					OIL	GAS	OIL	GAS
	BMW 3 Series (E36) 2 & 4 Door Saloon, Coupe	6/92~1/95	320i, 323i, 325i, 328i, 325td, 325tds (E36) (exc. East European Spec)	R L		334901 334902		343255
6/92~3/98		East European spec 320i, 323i, 325i, 328i, 325td, 325tds (E36) (exc. M~Technik Sus., M3)					343255	
2/95~3/98		320i, 323i, 325i, 328i, 325td, 325tds (E36) (exc. M~Technik Sus., M3) (exc. East European Spec)	R L		333919 333920		343255	
	BMW 3 Series (E36) Cabriolet Convertible	3/93~3/98	318i (E36) (exc. M~Technik Sus.) (exc. East European Spec)	R L		334901 334902		343255
3/93~3/98		East European spec 318i, 320i, 323i, 325i, 328i (E36)					343255	
1/94~1/95		318i (E36) (exc. M~Technik Sus.) (exc. East European Spec)	R L		334901 334902		343255	
2/95~3/98		318i (E36) Cabriolet Convertible (exc. M~Technik Sus., M3) (exc. East European Spec)	R L		333919 333920		343255	
4/94~01		316g, 316i, 318i, 318tds (E36) (exc. 323i, East European Spec)	R L		333909 333910		343268	
	BMW 3 Series (E36) Touring Estate	10/94~99	316i, 318i, 320i, 323i, 328i, 318tds (E36) (exc. East European Spec)	R L		333919 333920		343352
10/94~99		318tds, 320i, 323i, 325tds (E36)					343352	
11/95~99		318i, 328i (E36)					343352	
2/98~2/05		318i (E46) w/ Sport Sus.					343352	
2/98~4/05		320d (E46) w/ Sport Sus.					343352	
2/98~6/00		328i (E46) w/ Sport Sus.					343352	
3/98~9/00		323i (E46) w/ Sport Sus.					343352	
3/98~9/00		323i (E46) (exc. Sport Sus., Bad Rad Sus.)	R L		334945 334946		343352	
2/98~9/01		318i (87 kw) (E46) (exc. Sport Sus., Bad Road Sus.)	R L		339727 339728		343352	
3/98~2/05		320i (E46) (exc. Sport Sus., Bad Rad Sus.)	R L		334945 334946		343352	
	BMW 3 Series (E46) 2 & 4 Door Saloon	3/98~2/05	320i (E46) w/ Sport Sus.					343352
4/98~9/01		320d (100 kw) (E46) (exc. Sport Sus., Bad Road Sus.)	R L		339727 339728		343352	
9/98~2/05		316i (77 kw, 1895 ccm) (E46) (exc. Sport Sus., Bad Road Sus.)	R L		339727 339728		343352	
9/98~2/05		316i (E46) w/ Sport Sus.					343352	
9/98~6/00		328i (E46) 2 & 4 Door Saloon (exc. Sport Sus., Bad Rad Sus.)	R L		334945 334946		343352	
10/99~2/05		320i Touring Estate (E46) 330d (135kw) (E46) (exc. Sport Sus., Bad Road Sus.)	R L		334945 334946		343352	
10/99~2/05		330d (135kw) (E46) (exc. Sport Sus., Bad Road Sus.)	R L		334945 334946		343352	
4/00~2/05		316i (77 kw, 1596ccm) (E46) (exc. Sport Sus., Bad Road Sus.)	R L		339727 339728		343352	
6/00~2/05		330i (E46) (exc. Sport Sus., Bad Road Sus.)	R L		334945 334946		343352	
9/00~2/05		325i (E46) (exc. Sport Sus., Bad Road Sus.)	R L		334945 334946		343352	
9/00~2/05		325i (E46) w/ Sport Sus.					343352	
9/01~2/05		318i (105 kw), 320d (110kw) (E46) 318d w/ Sport Sus. (exc. Sport Sus., Bad Road Sus.)					343352	
2/02~2/05		316i (85 kw) (E46) (exc. Sport Sus., Bad Road Sus.)					343352	
3/03~2/05		330d (150kw) (E46) (exc. Sport Sus., Bad Road Sus.)					343352	
		BMW 3 Series (E46) Coupe	4/99~6/00	328Ci (E46) (exc. Sport Sus., Bad Rad Sus. Xi)	R L		334945 334946	
4/99~6/00	328Ci (E46) w/ Sport Sus.		R L		334614 334615		343352	

製造商	車款	年份	規格	R	前		後	
					KYB No.		KYB No.	
					OIL	GAS	OIL	GAS
BMW 3 Series ( E46 ) Coupe	4/99~9/00	323Ci ( E46 ) ( exc. Sport Sus., Bad Rad Sus. Xi )	R		334945		343352	
			L		334946			
	4/99~9/00	323Ci ( E46 ) w/ Sport Sus.	R		334614		343352	
			L		334615			
	8/99~9/06	320Ci ( E46 ) ( exc. Sport Sus., Bad Rad Sus. Xi )	R		334945		343352	
			L		334946			
	8/99~9/06	320Ci ( E46 ) w/ Sport Sus.	R		334614		343352	
			L		334615			
	11/99~9/06	316Ci, 318Ci ( E46 ) w/ Sport Sus. ( exc. Bad Road Sus. )	R		334614		343352	
			L		334615			
	6/00~9/06	330Ci ( E46 ) ( exc. Sport Sus., Bad Road Sus. Xi )	R		334945		343352	
			L		334946			
	00~9/06	325 Ci ( E46 ), Coupe ( exc. Sport Sus., Bad Rad Sus. Xi )	R		334945		343352	
			L		334946			
	9/01~9/06	325Ci ( E46 ) w/ Sport Sus.	R		334614		343352	
			L		334615			
	3/03~9/06	330Cd ( E46 ) ( exc. Sport Sus., Bad Road Sus. Xi )	R		334945		343352	
			L		334946			
	3/03~9/06	330Cd ( E46 ) w/ Sport Sus	R		334614		343352	
			L		334615			
11/03~9/06	320Cd ( E46 ) ( exc. Sport Sus., Bad Road Sus. Xi )	R		334945		343352		
		L		334946				
11/03~9/06	320Cd ( E46 ) w/ Sport Sus	R		334614		343352		
		L		334615				
BMW 3 Series ( E46 ) Touring Estate	10/99~2/05	320i ( E46 ) ( exc. Sport Sus., Bad Road Sus. )	R		334945		343352	
			L		334946			
	10/99~2/05	318i ( E46 ) ( exc. Sport Sus., Bad Road Sus. )	R		339727		343352	
			L		339728			
	10/99~2/05	318i, 320i, 325i, 328i, 330i, 320d, 330d ( E46 ) w/ Sport Sus. ( exc. Bad Road Sus. )					343352	
	10/99~6/00	328i ( E46 ) ( exc. Sport Sus., Bad Road Sus. )	R		334945		343352	
			L		334946			
	6/00~2/05	330i ( E46 ) ( exc. Sport Sus., Bad Road Sus. )					343352	
	9/00~2/05	328i ( E46 ) ( exc. Sport Sus., Bad Road Sus. )					343352	
	3/02~2/05	316i ( E36 ) w/ Sport Sus	R		334614		343352	
			L		334615			
	3/02~2/05	316i, 318d ( E46 ) ( exc. Sport Sus., Bad Road Sus. )	R		339727		343352	
			L		339728			
	3/00~2/05	320d ( E46 ) ( exc. Sport Sus., Bad Road Sus. )	R		339727		343352	
			L		339728			
	BMW 3 Series ( E46 ) Cabriolet, Convertible	4/00~	318Ci, 320Ci, 323Ci, 325Ci, 330Ci, 320Cd, 330Cd ( E46 ) ( exc. Sport Sus., Bad Road Sus., M3 )	R		334945		343352
				L		334946		
4/00~		318Ci, 320Ci, 323Ci, 325Ci, 330Ci, 320Cd, 330Cd ( E46 ) W/ Sport Sus.	R		334614		343352	
			L		334615			
BMW 3 Series ( E46 ) 3 & 5 Door Hatchback	6/01~2/05	316ti ( E46 ) W/ Sport Sus.	R		334614		343352	
			L		334615			
	6/01~2/05	325ti ( E46 ) ( exc. Sport Sus. )					343352	
9/01~2/05	318ti ( E46 ) W/ Sport Sus.	R		334614		343352		
		L		334615				
9/01~2/05	320td 3 & 5 Door Hatchback ( E46 ) ( exc. Sport Sus. )					343352		

製造商	車款	年份	規格	R	前		後	
					KYB No.		KYB No.	
					OIL	GAS	OIL	GAS
BMW 3 Series ( E90 )	1/05~12/11	All 2&4 Door Saloon ( E90 ) ( exc. Bad road Sus., Sport Sus., 4WD, M3 )	R		339269		349041	
			L		339270			
BMW 3 Series ( E91 )	1/05~12/11	All 2&4 Door Saloon ( E90 ) W/ Bad Road Sus. ( exc. Sport Sus., 4WD, M3 )	R		339269		349042	
			L		339270			
BMW 3 Series ( E91 )	9/05~	316i, 318i, 320i, 323i, 325i, 330i, 335i, 316d, 318d, 320d, 325d, 330d, 335d ( E91 ) Touring Estate ( exc. Bad Road Sus., Sport Sus., 4WD )	R		339269		349041	
			L		339270			
BMW 3 Series ( E92 )	9/06~	316i, 318i, 320i, 325i, 330i, 335i, 320d, 325d, 330d, 335d ( E92 ) Coupe ( exc. Sport Sus. )	R		339269		349041	
			L		339270			
BMW 3 Series ( E93 )	3/07~	318i, 320i, 325i, 330i, 335i, 320d, 325d, 330d ( E93 ) Cabriolet Convertible ( exc. Sport Sus., Bad Road Sus. )	R		339269		349041	
			L		339270			
BMW 5 Series ( E28 )	7/81~12/87	518, 518i, 524D( E28 )			365043			
					365043			
	7/81~3/86	525i ( E28 ) w/ ABS			365043		341080	
					365043			
	3/82~3/86	525i ( E28 ) w/ ABS			365043			
					365043			
3/83~3/86	524 TD( E28 )			365043				
				365043				
BMW 5 Series ( E34 )	4/86~12/87	520i, 525e, 524 TD, 525i ( E28 ) w/o ABS 528i, 535i( E28 )			365043		341080	
					365043			
	11/87~7/90	530i, 535, 524TD, 525i ( E34 ) W/ Sport Sus.			366005		341081	
					366005			
	1/88~7/90	518i, 520i ( E34 ) ( exc. Sport Sus. )			365069		341081	
					366005			
	1/88~7/90	518i, 520i ( E34 ) W/ Sport Sus.			366005		341081	
					366005			
	8/90~12/94	518i, 520i ( E34 ) ( exc. Sport Sus. )			365505		341081	
					365505			
	8/90~9/92	518i, 520i, 525i, 524TD, 525TDS( E34 ) W/ Sport Sus.			366007		341081	
					366007			
	8/90~12/95	530i, 535i, 540i ( E34 ) W/ Sport Sus.			366007		341081	
					366007			
	91~12/94	518i, 520i ( E34 ) ( exc. Sport Sus. )			365505		341146	
					365505			
	91~3/97	518i, 518g, 520i, 525td( E34 ) w/Sport Sus.			366007		341146	
					366007			
	91~3/97	525tds ( E34 ) ( exc. Sport Sus. )			366007		341146	
					366007			
91~3/97	525td ( E34 ) ( exc. Sport Sus. )			365505		341146		
				365505				
91~12/94	525i ( E34 ) w/ Sport Sus.			366007				
				366007				
91~3/97	530i, 540i ( E34 ) w/ Sport Sus.			366007				
				366007				
10/92~12/95	518i, 520i, 525i, 525td, 525 tds ( E34 ) W/ Sport Sus.			365505		341081		
				365505				
1/95~12/95	518i, 520i ( E34 ) ( exc. Sport Sus. )			365505		341081		
				365505				
1/95~9/97	518i, 518g, 520i ( E34 ) ( exc. Sport Sus. )			365505		341146		
				365505				
1/95~3/97	525i ( E34 ) w/ Sport Sus.			366007				
				366007				
BMW 5 Series ( E39 )	11/95~6/03	520i, 523i, 525i, 528i, 530i, 520d, 525d, 525td, 525tds, 530d ( E39 ) ( exc. Sport Sus. )	R		335811		341840	
			L		335812			
	11/95~6/03	535i, 540i ( E39 ) ( exc. Sport Sus. )			335917		341840	
					335917			
1/97~5/04	520i, 523i, 525i, 528i, 530i, 520d, 525d, 525tds, 530d ( E39 ) *rear=coil spring Sus. ( exc. Sport Sus. )	R		335811		344700		
		L		335812				
1/97~5/04	520i, 523i, 525i, 528i, 530i, 520d, 525d, 525tds, 530d ( E39 ) *rear= Air spring Sus. ( exc. Sport Sus. )	R		335811		344701		
		L		335812				
1/97~5/04	540i ( E39 ) *rear= Air spring Sus. ( exc. Sport Sus. )			335917		344701		
				335917				
BMW 5 Series ( E60 )	7/03~3/10	All ( E60 ) ( exc. Sport Sus. )	R		335815		341704	
			L		335816			
BMW 5 Series ( E61 )	6/04~	All ( E61 ) ( exc. Sport Sus. )	R		335817		344702	
			L		335818			
BMW 6 Series ( E24 )	6/82~90	628CSI, 630CSI, 633CSI, 635CSI ( E24 )			365043			

製造商	車款	年份	規格	前		後	
				KYB No.		KYB No.	
				OIL	GAS	OIL	GAS
BMW 7 Series ( E32 )		3/88~7/90	730i, 730iL, 735i, 735iL ( E32 ) 2 & 4 Door Saloon w/Sport Sus., ( exc. M~Technik Sus., EDC )		366005		341129
		8/90~1/92	730i, 730iL ( E32 ) 2 & 4 Door Saloon w/Sport Sus., ( exc. M~Technik Sus., EDC )		366007		341129
		8/90~94	735i, 735iL ( E32 ) 2 & 4 Door Saloon w/Sport Sus., ( exc. M~Technik Sus., EDC )		366007		341129

CITROEN

製造商	車款	年份	規格	前		後	
				KYB No.		KYB No.	
				OIL	GAS	OIL	GAS
CITROEN	Citroen C4	11/04~	1.4i, 1.6i, 1.6THP, 1.6 Vti, 1.6 HDi, 1.6 16V Bio-Flex, 2.0i, 2.HDi ( exc. Sport Sus., Bad Road Sus. )	R	333757		344407
				L	333758		
	Citroen C4 II	11/09~	All B7 w/ Bad Road Sus.				344408

CITROEN COMMERCIAL

製造商	車款	年份	規格	前		後	
				KYB No.		KYB No.	
				OIL	GAS	OIL	GAS
CITROEN COMMERCIAL	Citroen Berlingo	12/02~5/08	All G/ M/ MF	R	333729		341237
				L	333730		

MERCEDES BENZ

製造商	車款	年份	規格	前		後	
				KYB No.		KYB No.	
				OIL	GAS	OIL	GAS
MERCEDES BENZ	Mercedes Benz 190 ( W201 )	12/82~93	190, 190E, 190D ( W201 ) ( exc. 190E 2.3~16, 2.5~16, Sport Sus. )		334017		
	Mercedes Benz E ( W124 )	85~93	200, 200E, 230E, 260E, 300E, 320E, 400E, 200D, 250D, 250 TurboD, 300D, 300D-Turbo ( W124 ) ( exc. 4~Matic 4WD, Sport Sus. )		334017		
	Mercedes Benz E ( S124 )	85~93	200T, 230TE, 280TE, 300TE, 320TE, 200TD, 250TD, 300TD-Turbo ( S124 ) ( exc. Sport Sus., 4~Matic 4WD )		334017		
	Mercedes Benz E ( C124 )	87~93	230CE, 300CE, 320CE ( C124 ) ( exc. Sport Sus. )		334017		
	Mercedes Benz E ( W124 )	93~95	E200, E220, E280, E320, E420, E200D, E250D, E250D Turbo, E300D, E300D-Turbo ( W124 ) ( exc. 4~Matic 4WD, Sport Sus. )		334017		
	Mercedes Benz E ( C124 )	93~95	E220C, E320C ( C124 ) ( exc. Sport Sus. )		334017		
	Mercedes Benz E ( S124 )	93~95	E200T, E220T, E280T, E320T, E250TD, E300TD, E300TD-Turbo ( S124 ) ( exc. Sport Sus., 4~Matic 4WD )		334017		
	Mercedes Benz C ( W203 )	5/00~07	All 2 & 4 door Saloon ( W203 ) ( exc. 4~ Matic 4WD )		335920		
	Mercedes Benz C ( S203 )	1/01~07	All Estate ( S203 ) ( exc. 4~ Matic 4WD, Height Control )		335920		
	Mercedes Benz C ( CL203 )	3/01~6/11	All Coupe ( CL203 ) ( exc. 4~ Matic 4WD )		335920		
	Mercedes Benz CLK ( C209 )	6/02~5/09	CLK 200 CGI, CLK200 Kompressor, CLK240, CLK280, CLK320, CLK350, CLK500, CLK220CDI, CLK320CDI, CLK270CDI ( C209 ) Coupe ( exc. Higher Sus., Sport Sus. )		335920		
	Mercedes Benz CLK ( A209 )	2/03~3/10	CLK 200 CGI, CLK200 Kompressor, CLK240, CLK280, CLK320, CLK350, CLK500, CLK320CDI ( A209 ) Cabrio ( exc. Higher Sus., Sport Sus. )		335920		

MINI

製造商	車款	年份	規格	前		後	
				KYB No.		KYB No.	
				OIL	GAS	OIL	GAS
MINI	Mini ( D )	9/01~3/02	One, One D ( R50, R52, R53 )				341924
		9/01~9/02	Cooper, Cooper S ( R50, R52, R53 )				341924
		3/02~10/06	One, Cooper ( R50, R52, R53 )	R	334621		341924
				L	334622		341924
		4/02~10/06	Cooper S ( R50, R52, R53 )	R	334621		341924
				L	334622		341924
		5/03~10/06	One D ( R50, R52, R53 )	R	334621		341924
				L	334622		341924
		7/04~10/06	Cooper S ( R50, R52, R53 )	R	334621		341924
				L	334622		341924
10/06~	ONE, One D, Cooper, Cooper D, Cooper S, Cooper SD ( R56, R57 ), Incl. Cabriolet ( exc. Sport Sus. )	R	334698		341683		
		L	334699		341683		

OPEL

製造商	車款	年份	規格	前		後	
				KYB No.		KYB No.	
				OIL	GAS	OIL	GAS
OPEL	Opel Vectra B	9/95~3/02	1.6i, 1.8i, 1.7TD, 2.0i, 2.0 Di, 2.0 DTi, 2.2i, 2.2DTi, incl 16V ( exc. Sport Sus. )	R	333715		341841
				L	333716		
		9/95~3/02	2.5i V6, 2.6i V6 ( exc. Sport Sus. )	R	334600		341841
				L	334601		
		9/95~3/02	All w/ Sport Sus., ( exc. i 500 )	R	334609		341841
				L	334610		
	Opel Corsa C	9/00~	1.0, 1.2, 1.3 CDTi, 1.7 Di ( exc. Bad Road Sus., Sport Sus. )	R	333755		343350
				L	333756		
		9/00~	1.4, 1.8, 1.7CDTi, 1.7 DTi ( exc. Bad Road Sus., Sport Sus. )	R	333755		343351
				L	333756		
Opel Combo	10/01~	All ( exc. Bad Road Sus. )	R	333755		343308	
			L	333756			
Opel Meriva	5/03~5/10	All ( exc. Turbo )	R	333755		343308	
			L	333756			

PEUGEOT

製造商	車款	年份	規格	前		後	
				KYB No.		KYB No.	
				OIL	GAS	OIL	GAS
PEUGEOT	Peugeot 307	4/01~	All 307 ( exc. Bad Road Sus. )	R	333757		344407
				L	333758		
		4/01~	All 307SW ( exc. Bad Road Sus. )	R	333757		344408
				L	333758		
		4/01~	All 307, 307SW w/Bad Road Sus.	R	338714		344408
				L	338715		
		10/03~	All 307CC ( exc. Bad Road Sus. )	R	333757		344408
				L	333758		
		10/03~	All 307CC w/ Bad Road Sus.	R	338714		344408
				L	338715		

製造商	車款	年份	規格	R	前		後	
					KYB No.		KYB No.	
					OIL	GAS	OIL	GAS
Peugeot 308 SW I	9/07~	1.4 16V, 1.6 16V w/ Bad Road Sus.	R		333768		344408	
			L		333769			
	9/07~	1.6 HDi (exc. Bad Road Sus)	R		333768		344408	
			L		333769			
	9/07~	2.0 HDi (exc. Bad Road Sus)	R		333770		344408	
			L		333771			
	9/07~	1.6 HDi w/ Bad Road Sus	R		333772		344408	
			L		333773			
	1/08~	2.0 Bioflex (exc. Bad Road Sus)	R		333768		344408	
			L		333769			
	1/08~	2.0 16V w/ Bad Road Sus	R		333772		344408	
			L		333773			
3/08~	1.6 16V (exc. Bad Road Sus)	R		333768		344408		
		L		333769				
3/09~	1.6 Bioflex w/ Bad Road Sus	R		333768		344408		
		L		333769				
12/09~	1.4 16V (exc. Bad Road Sus)	R		333768		344408		
		L		333769				
Peugeot 308 CC	4/09~	All (exc. Bad Road Sus)	R		333772		344407	
			L		333773			
Peugeot 406	95~04	All (exc. Bad Road Sus)	R		333727		341230	
			L		333728		341229	
	95~04	All w/ Bad Road Sus					341231	

製造商	車款	年份	規格	R	前		後	
					KYB No.		KYB No.	
					OIL	GAS	OIL	GAS
	Skoda Fabia Fabia II	12/06~	1.2, 1.2 12V, 1.2 TSi, 1.2 TDi, 1.4, 1.4 TSi, 1.4 TDi, 1.6, 1.6 TDi, 1.9 TDi (exc. Bad Road Sus., Sport Sus.)			334835	343328	
		12/06~	1.2, 1.2 12V, 1.2 TSi, 1.2 TDi, 1.4, 1.4 TSi, 1.4 TDi, 1.6, 1.6 TDi, 1.9 TDi w/ Bad road Sus. (exc. Sport Sus.)			334835	343348	
		12/06~	1.2, 1.2 12V, 1.2 TSi, 1.2 TDi, 1.4, 1.4 TSi, 1.4 TDi, 1.6, 1.6 TDi, 1.9 TDi w/ Sport Sus., (exc. Bad Road Sus.)			334835	343485	
	Skoda Octavia I	9/96~12/10	2WD 1.4, 1.4 16V, 1.6, 1.9 SDi ( 1U2 ) (exc. Sport Sus., Bad Road Sus.)			333713	343348	
		9/96~12/10	2WD 1.8, 1.8T, 1.9 TDi, 2.0 ( 1U2 ) (exc. Sport Sus., Bad Road Sus., RS )			334812	343348	
	Skoda Octavia II	2/04~2/13	2WD All, ( 1Z3 ) (exc. Sport Sus., Bad Road Sus., RS )			334834(2) 335808(1)	344459	
	Skoda Octavia II Combi	2/04~2/13	2WD 4WD All, ( 1Z5 ) (exc. Sport Sus., Bad Road Sus., RS )			334834(2) 335808(1)	344459	
	Skoda Superb	2/02~3/08	All ( 3U4 ) (exc. Bad Road Sus.)			341844	343281	
		2/02~3/08	All ( 3U4 ) w/ Bad road Sus.			341301	345027	
		3/08~	2WD, 4WD 1.4TSi, 1.6 TDi, 1.8TSi, 1.9 TDi, 2.0 TSi, 2.0 TDi, 3.6 V6 ( 3T4, 3T5 ) (exc. Bad Road Sus., Sport Sus.)			335808	349088	
	Skoda Yeti	5/09~	1.2 TSi, 1.4TSi, 1.8 TSi, 1.6 TDi, 2.0 TDi(5L), Incl 4WD, (exc. Bad Road Sus.)			334834 (2) 335814 (1)	344459	
		5/09~	1.2 TSi, 1.4TSi, 1.8 TSi, 1.6 TDi, 2.0 TDi( 5L ), Incl 4WD, w/ Bad Road Sus.			334834 (2) 335814 (1)	349137	

SAAB

製造商	車款	年份	規格	R	前		後	
					KYB No.		KYB No.	
					OIL	GAS	OIL	GAS
SAAB								
	Saab 900	9/93~98	3 door Liftback Hardtop, 2 & 4 Door Saloon, 2.0, 2.0 Turbo, 2.3, 2.5 V6			366010	343270	
		9/93~98	Cabriolet, 2.0, 2.0 Turbo, 2.3, 2.5 V6			366009	343270	
	Saab 9~3	4/98~8/02	All coupe, 3 Door Liftback, Hardtop (YS3D)			366012	343270	
		4/98~5/03	All Cabriolet			366012	343270	

SKODA

製造商	車款	年份	規格	R	前		後	
					KYB No.		KYB No.	
					OIL	GAS	OIL	GAS
SKODA								
	Skoda Roomster, Praktik	3/06~	1.2, 1.2 TSi, 1.4, 1.4 TDi, 1.6, 1.6 TDi, 1.9 TDi ( 5J )			334835	343298	
	Skoda Fabia Fabia I	8/99~12/07	1.0, 1.2, 1.4, 1.4 16V, 1.4 TDi, 1.9 SDi, 1.9 TDi, 2.0 ( 6Y ) (exc. Bad Road Sus.)			334835	334328	
		8/99~12/07	1.0, 1.2, 1.4, 1.4 16V, 1.4 TDi, 1.9 SDi, 1.9 TDi, 2.0 ( 6Y ) w/ Bad Road Sus.			334835	343348	

SMART

製造商	車款	年份	規格	R	前		後	
					KYB No.		KYB No.	
					OIL	GAS	OIL	GAS
SMART								
	City-Coupe	7/98~12/00	0.6, 0.8CDi ( 450 ) w/ Leaf spring Sus (exc. Brabus)			332900	343440	
		7/98~1/04	0.6, 0.7, 0.8CDi ( 450 ) w/ Coil Spring Sus. (exc. Brabus)			332901	343440	
	Cabrio	3/00~12/00	0.6, ( 450 ) w/ Leaf Spring Sus. (exc. Brabus)			332900	343440	
		3/00~1/04	0.6, 0.7, 0.8CDi ( 450 ) w/ Coil Spring Sus. (exc. Brabus)			332901	343440	
	Cross-blade	6/02~12/03	0.6 w/ Coil Spring Sus. ( 450 ) (exc. Brabus)			332901	343440	
	Fortwo Coupe, Fortwo Cabrio	1/04~1/07	0.7, 0.8 CDi ( 3 & 5 Door Hatchback, Cabrio ) w/ Coil Spring Sus. ( 450 ) (exc. Brabus)			332901	343440	
	Roadster & Coupe	4/03~11/05	0.7 Cabrio w/ Coil Spring Sus. ( 452 ) (exc. Brabus)			332901	343440	

VOLKSWAGEN

製造商	車款	年份	規格	R L	前		後	
					KYB No.		KYB No.	
					OIL	GAS	OIL	GAS
VOLKSWAGEN								
	Volkswagen Bora , Jetta IV	9/97~5/05	2WD 1.4, 1.6 ( 1J ) ( exc. Sport Sus, Bad Road Sus. )		333713		343348	
		9/97~5/05	2WD 1.8, 1.8 Turbo, 2.0, 2.3, 1.9 SDI, 1.9TDI ( 1J ) ( exc. Sport Sus., Bad Road Sus. )		334812		343348	
		9/97~5/05	2WD All w/ Sport Sus, Bad Road Sus. ( 1J ) ( exc. 2.8 V6 )		334812			
		9/97~5/99	4WD All w/ Sport Sus, Bad Road Sus. ( exc. 2.8V6 )		334812		343310	
		9/97~5/99	4WD All w/ Bad Road Sus. ( exc. 2.8V6 )		334812		344301	
	Volkswagen Bora Variant	99~5/05	2WD 1.8, 2.3, 1.9SDI, 1.9TDI ( 1J ) ( exc. Sport Sus., Bad Road Sus ) 2WD All, w/ Sport Sus, Bad Road Sus. ( 1J )		334812			
	Volkswagen Corrado	8/87~12/95	1.8 16V , 1.8G60, 2.0i, 2.0i 16V ( 53i )		334810		343258	
		8/91~12/95	VR6 ( 53i )		334810		343191	
	Volkswagen Eos	3/06~	1.4 TSi, 1.6 FSi, 2.0 FSi, 2.0TFSi, 2.0 TSi, 2.0 TDi, 2.0 TDi 16V, 3.2V6, 3.6 V6 ( 1F7 ) incl Sport Sus.		335808		349022	
	Volkswagen Fox	4/05~	1.2i, 1.4i, 1.4TDI ( 5Z1 )		334835		343438	
	Volkswagen Golf Cabrio	9/93~2/98	Golf III All , Incl. Sport Sus.		334810		343191	
		3/98~6/02	Golf IV All , Incl. Sport Sus.		334810		343191	
	Volkswagen Golf II	8/83~12/89	2WD Golf All. Chassis No. 1GLW320000 ( exc. GTI, GTI 16V, G60 )		333712			
		8/83~12/89	2WD Golf All. Chassis No. 1GLW320000 ( exc. GTI, GTI 16V, G60 )		364014		343191	
		1/84~12/89	2WD Golf GTI ( exc. 16V, G60 )		333712			
		1/84~12/89	2WD Golf GTI ( exc. 16V, G60 )		364014		343191	
		2/86~12/89	2WD Golf GTI 16V 4WD Golf Syncro ( exc. Rally, Country )		333712			
		2/86~12/89	4WD Golf Syncro ( exc. Rally, Country )		364014		343274	
		10/89~7/91	Golf 1.8 GTi G60		334810		343258	
		1/90~92	2WD Golf Gti 16V		333712		343258	
	Volkswagen Golf II, Jetta II	1/90~92	2WD Golf All, Jetta All, Chassis No. 1G LW320001 ( exc. GTI, GTI 16V, G60 )		333712		343191	
		1/90~92	2WD Golf Gti ( exc. 16V, G60 ) Jetta GTI, GT, 16V ( exc. 16V, G60 )		333712		343191	
		1/90~92	4WD Golf Syncro ( exc. Rally, Country ) Jetta Syncro		333712		343274	
	Volkswagen Golf III, Variant	9/93~98	1.4i, 1.6i, 1.8i, 1.9D, 1.9TD, 1.9TDi ( 1H ) ( exc. Syncro )		333712		341803	
		9/93~98	2.0, 1.9SDI, 2.9VR6, ( 1H ) ( exc. Syncro )		334810		341803	

製造商	車款	年份	規格	R L	前		後	
					KYB No.		KYB No.	
					OIL	GAS	OIL	GAS
	Volkswagen Golf III, Vento, Jetta III ( exc Bad Road Sus. )	9/91~98	2WD Golf, Vento, 1.4i, 1.6i, 1.8i, 1.9Diesel, 1.9 Turbo Diesel, 1.9 Tdi, Incl. GT ( 1H )		333712		343191	
9/91~98		2WD Golf, Vento, 2.0GTI, 2.0 16V GTI, 2.8 VR6, 2.8V, 1.9 SDI, 2.0 8V( 1H )		334810		343258		
1/93~98		4WD Golf Syncro, 1.8 ( 1H ) ( exc. Country )		333712				
10/94~98		4WD Golf, Vento Syncro, 2.0, 2.9 VR6, 1.9 TDI ( 1H ) ( exc. Country )		334810				
	Volkswagen Golf V	10/03~2/09	2WD /4WD All ( 1K1 ) ( exc. Sport Sus., Bad road Sus., 3.2 )		334834(1) 335808(2)		344459	
	Volkswagen Golf V Plus	1/05~	2WD All ( 5M ) w/ Sport Sus. ( exc. Bad Road Sus. )		334834(1) 335808(2)		344459	
	Volkswagen Golf V Variant	6/07~	2WD /4WD all ( 1K5 ) ( exc. Sport Sus., Bad Road Sus. )		334834(1) 335808(2)		344459	
	Volkswagen Golf IV	9/97~10/03	2WD ( 1J1 ) , 1.4, 1.6, 1.6 FSi ( exc. Sport Sus. Bad Road Sus. )		333713		343348	
		9/97~10/03	2WD ( 1J1 ) , 1.8, 1.8 Turbo, 2.0, 2.3, 1.9 SDI, 1.9 TDi ( exc. Sport Sus, Bad Road Sus. )		334812		343348	
		9/97~10/03	2WD All ( 1J1 ) w/Sport Sus.		334812			
	Volkswagen Golf IV Variant	9/97~6/05	2WD All ( 1J1 ) w/Bad Road Sus. ( exc. 2.8V6 )		334812			
		9/97~5/99	4WD ( 1J1 ) 1.8, 2.3, 1.9TDI ( exc. 2.8V6 ) 4WD All ( 1J1 ) w/ Sport Sus ( exc. 2.8V6 ) Chassis No. 1J~X~800 000		334812		343310	
	Volkswagen Golf VI	9/97~5/99	4WD All ( 1J1 ) w/ Bad Road Sus. ( exc. 2.8V6 ) Chassis No. 1J~X~800 000		334812		344301	
		99~6/06	2WD , 2.0, 2.3, 1.9SDI, 1.9TDi ( 1J5 ) ( exc. Sport Sus, Bad Road Sus. )		334812		343298	
	Volkswagen Golf VI Variant	99~6/06	2WD All ( 1J5 ) w/ Sport Sus, Bad Road Sus.		334812			
	Volkswagen Jetta II	3/84~12/89	2WD Jetta All No. Chassis No. 1GLW320000 ( exc. GTI, GTI 16V, G60 )		333712			
	Volkswagen Jetta V	3/84~12/89	2WD Jetta GTI, GT, 16V		333712			
		3/84~12/89	2WD Jetta GTI, GT, 16V		364014		343191	
		8/87~12/89	4WD Jetta Syncro		333712			
	Volkswagen Jetta VI	8/87~12/89	4WD Jetta Syncro		364014		343274	
	Volkswagen Jetta V	8/05~10/10	All ( 1K2 ) ( exc. Sport Sus., Original Lowered Vehicle )		334834(1) 335808(2)		344459	
	Volkswagen Jetta VI	4/10~	All ( 162 ) incl. Sport Sus. ( exc. Bad Road Sus. )		334834(1) 335808(2)		344459	
		4/10~	All ( 162 ) incl. Bad Road Sus. ( exc. Sport Sus. )		334834(1) 335808(2)		349137	

製造商	車款	年份	規格	R L	前		後	
					KYB No.		KYB No.	
					OIL	GAS	OIL	GAS
Volkswagen Lupo		98~7/05	1.0, 1.4, 1.4TDi, 1.7 SDi, (6X) (exc. 3L)			333712		343309
		98~7/05	1.6 GTI (6X) (exc. 3L)					343309
		01~	1.2 TDi, 1.4 FSI (6X, 6E)					343309
Volkswagen New Beetle		1/98~	All (1C, 9C, 1Y7)			334812		343348
Volkswagen Polo Derby		9/94~10/99	1.0, 1.05, 1.3, 1.4, 1.6, 1.7 SDi, 1.9D, 1.9SDi (6N1)			333712		343274
		95~9/01	Classic 1.4, 1.6, 1.7 SDi (6KV2)			333712		343274
		95~9/01	Classic 1.8, 1.9SDi, 1.9TDi (6KV2)			334810		343274
		10/99~9/01	1.0, 1.4, 1.4TDi, 1.7 SDi, 1.9SDi, 1.9D (6N2)			333712		343274
		99~9/01	1.6 GTi (6N2)					343274
Volkswagen Polo		10/01~11/09	All (9N, 9A4) (exc. Sport Sus., Bad Road Sus., Cup Edition)			334835		343328
Volkswagen Polo Variant		97~9/01	1.4, 1.6, 1.8, 1.7SDi, 1.9SDi (6KV5)			333712		343297
		97~9/01	1.9TDi (6KV5)			334810		343297
Volkswagen Passat, Santana (~88)		11/80~3/83	Passat 2 or 4 Door Saloon All (32B) (exc. Bad Road Sus.)			365500		
		3/81~83	Passat Variant Estate All (32B) (exc. Bad Road Sus.)			365500		
		82~3/83	Santana Chassis No.32D155757 (exc. Bad Road Sus.)			365500		
		4/83~3/88	2WD (32B) Passat 2 or 4 Door Saloon All Passat Variant Estate All Santana Chassis No., 32D155758 (exc. Bad Road Sus.)			365500		343206
		8/84~8/88	Syncro All (32B) (exc. Bad Road Sus.) Syncro 2 or 4 Door Saloon, Estate all w/ Bad Road Sus. (32B)			365500		
Volkswagen Passat (88-96)		4/88~7/91	2WD All 2 & 4 Door Saloon, Variant Estate All, (3A2, 351) (exc. 2.8 VR6, Airspring Sus, Bad Road Sus.)			365502		343223
		4/88~7/91	2WD All 2 & 4 Door Saloon, Variant Estate All, (3A2, 351) (exc. 2.8 VR6, Airspring Sus, Bad Road Sus.)			334810		
		9/89~7/91	4WD Syncro, 1.8 G60 / 2.0 2 & 4 Door Saloon (3A2, 351) (exc. Bad Road Sus.)			348810		
		9/89~92	4WD Syncro, 1.8 G60 / 2.0 2 & 4 Door Saloon (3A2, 351) w/ Bad Road Sus.			334810		
		10/90~7/91	4WD Syncro, 1.8 G60 / 2.0 Estate (3A2, 351) (exc. Bad Road Sus.)			348810		
		8/91~92	2WD All 2 & 4 Door Saloon, Variant Estate All, (3A2, 351), Chassis No. P-026435 (exc. 2.8 VR6, Airspring Sus, Bad Road Sus.)			334810		343223

製造商	車款	年份	規格	R L	前		後		
					KYB No.		KYB No.		
					OIL	GAS	OIL	GAS	
Volkswagen Passat (88-96)		8/91~92	4WD Syncro, 1.8 G60 / 2.0 (3A2, 351) 2 & 4 Door Saloon, Estate, Chassis No. P-026435 (exc. Bad Road Sus.)					348810	
		8/91~96	2WD, 2.8VR6 2 & 4 Door Saloon, Estate (3A2, 351) (exc. Syncro, Height control, Bad Road Sus.)					334811	343223
		8/91~96	4WD, Syncro, 2.8 VR6 2 & 4 Door Saloon, Estate (3A2, 351) (exc. Height Control, Bad Road Sus.)					334811	
		92~96	2WD All 2 & 4 Door Saloon, Variant Estate All, (3A2, 351), Chassis No. P-026436 (exc. 2.8 VR6, Airspring Sus, Bad Road Sus.)					334811	343223
Volkswagen Passat (3B) (97-05)		92~96	4WD Syncro, 1.8 G60 / 2.0 2 & 4 Door Saloon, Estate (3A2, 351), Chassis No. P-026436 (exc. Bad Road Sus.)					334811	
		92~96	4WD Syncro, 1.8 G60/2.0 2 & 4 Door Saloon, Estate (3A2, 351) Chassis No. P-026436, w/ Bad Road Sus.					334811	
Volkswagen Passat (3B) (97-05)		97~05	2WD 2 or 4 Saloon All, Varian Estate All (3B2, 3B5) *Sus mounting kit#SM1711 Chassis No. 3B-YE121221 (exc. Sport Sus., Bad Road Sus., 2.5i V6, 2.8 V6)					341842	341281
		97~05	4WD Syncro, 2 or 4 Saloon All, Varian Estate All (3B2, 3B5) *Sus mounting kit#SM1711 Chassis No. 3B-YE121221 (exc. Sport Sus., Bad Road Sus., 2.5i V6, 2.8 V6)					341842	
		97~05	2WD Sport Sus., Syncro 4WD, 2 or 4 Saloon All, Varian Estate All (3B2, 3B5) *Sus mounting kit#SM1711 Chassis No. 3B-YE121221 (exc. Bad Road Sus., 2.5i V6, 2.8 V6)					341843	
		97~05	All w/ Bad Road Sus., Chassis No. 3B-YE121222 (exc. Syncro 4 motion)					341301	345027
		11/00~2/05	2WD 2 or 4 Saloon All, Varian Estate All (3B3, 3B6) (exc. Sport Sus. Bad Road Sus.)					341844	343281
		11/00~2/05	2WD w/ Sport Sus., All 2 or 4 Saloon (3B3), All Variant Estate (3B6) (exc. Bad Road Sus.) 4WD Syncro, All 2 or 4 Saloon (3B3), All Variant Estate (3B6) (exc. Sport Sus., Bad Road Sus., 4.0W8) 4WD Syncro w/ Sport Sus., All 2 or 4 Saloon (3B3), All Variant Estate (3B6), (exc. Bad Road Sus., 4.0 W8)					341844	
Volkswagen Passat (3B) (06-10)		06~10/00	2WD 2 or 4 Saloon All, Varian Estate All (3B2, 3B5) *Sus mounting kit#SM1712 Chassis No. 3B-YE121221 (exc. Sport Sus., Bad Road Sus., 2.5i V6, 2.8 V6)					341844	341281
		06~10/00	4WD, Syncro, 2 or 4 Saloon All, Varian Estate All (3B2, 3B5) *Sus mounting kit#SM1712 Chassis No. 3B-YE121221 (exc. Sport Sus., Bad Road Sus., 2.5i V6, 2.8 V6)					341844	
		06~10/00	2WD Sport Sus., Syncro 4WD, 2 or 4 Saloon All, Varian Estate All (3B2, 3B5) *Sus mounting kit#SM1712 Chassis No. 3B-YE121221 (exc. Bad Road Sus., 2.5i V6, 2.8 V6)					341844	
		06~10/00	2WD Sport Sus., Syncro 4WD, 2 or 4 Saloon All, Varian Estate All (3B2, 3B5) *Sus mounting kit#SM1712 Chassis No. 3B-YE121221 (exc. Bad Road Sus., 2.5i V6, 2.8 V6)					341844	

製造商	車款	年份	規格	R L	前		後	
					KYB No.		KYB No.	
					OIL	GAS	OIL	GAS
	Volkswagen Passat ( 3C2, 3C5 )	3/05~	2WD, 4WD All ( 3C2, 3C5 ) ( exc. Sport Sus., Original Lowered Vehicle, 3.6., Adjustable Shock Absorber, Height control )		335808		344459	
8/10~		RUS 2WD TDi ( 125kw ) incl. Bad road Sus., Sport Sus., Blue~motion		335808				
2/11~		RUS 2WD 1.8TFSI( 112kw ) incl. Bad road Sus., Sport Sus., Blue~motion		335808				
	Volkswagen Passat CC	5/08~	All 2WD , 4WD ( 357 )		335808		344459	
		11/11~	All 2WD , 4WD ( 358 )		335808		344459	
	Volkswagen Passat ( 362, 365 )	8/10~	All 2WD, 4WD ( 362 ), 2WD Estate ( 365 ) incl Bad Road Sus., Sport Sus., Blue~Motion ( exc. RUS , Raised Vehicle )		335808		344459	
		8/10~	All 4WD Estate ( 365 ) incl Bad road Sus., Sport Sus. ( exc. RUS , Raised Vehicle )		335808		344459	
	Volkswagen Scirocco	5/08~	1.4 TSi, 2.0 TSi, 2.0 TDi( 137 ) ( exc. Sport Sus. )		335808		344459	
	Volkswagen Sharan	5/10~	2WD,4WD All ( 7N ) incl. Sport Sus.		335808		344459	
	Volkswagen Touran	2/03~5/10	2WD All ( 1T1, 1T2 ) ( exc Sport Sus., , bad road Sus. )		335808		344459	
		5/10~	2WD All incl Bad Road Sus , Spor Sus. ( 1T3 )		335808		344459	
	Volkswagen Caddy Life, Caddy Maxi Life	3/04~	Caddy Life 2WD All ( 2K ) ( exc. H/D, Original Lowered Vehicle, 1.6 Bifuel, 2.0 Ecofuel )		334834(1) 335808(2)		344457	
		3/04~	Caddy Life 2WD All w/ H/D, Original Lowered vehicle ( 2K ) ( exc. 1.6 Bifuel, 2.0 Ecofuel )		334834(1) 335808(2)		344458	
		2/04~	Caddy 2WD All w/ H/D, Original Lowered Vehicle ( 2K ) ( exc. 1.6 Bifuel, 2.0 Ecofuel )		334834(1) 335808(2)		344458	
		5/08~	Caddy Life 4WD All, Caddy Life Maxi 4WD All ( 2K ) ( exc. H/D, original Lowered Vehicle )		335808		349201	
		11/08~	Caddy 4WD All, Caddy Maxi 4WD all ( 2K ) ( exc. H/D, Original Lowered Vehicle )		335808		349201	
		09~	Caddy Life Maxi 2WD All ( 2K ), incl H/D ( exc. Original Lowered Vehicle, 1.6 Bifuel, 2.0 Ecofuel )		335808		349227	
	8/10~	Caddy Maxi 2WD All incl w/ H/D ( 2K ) ( exc Original Lowered Vehicle , 1.6 Bifuel, 2.0 Ecofuel )		335808		349227		

VOLVO

製造商	車款	年份	規格	R L	前		後	
					KYB No.		KYB No.	
					OIL	GAS	OIL	GAS
VOLVO								
	Volvo 850	91~97	All ( LS ) ( exc. Original Lowered Vehicle )					344230
		92~97	All ( LW ) ( exc. Original Lowered Vehicle )					344230
	Volvo S 70	1/97~11/00	All S70, 2WD, 4WD ( exc. Original Lowered Vehicle )					344230
	Volvo C70	3/97~9/02	All C70, 2WD, 4WD ( exc. Original Lowered Vehicle )					344230
	Volvo V70	1/97~3/00	All V70, 2WD, 4WD ( exc. Original Lowered Vehicle )					344230
	Volvo s40 , V40	5/95~6/99	All Incl ABS ( exc. Sport Sus., T4 )	R		334154		341204
L					334155			
		5/95~6/99	Sport Sus., All Incl ABS ( exc. T4 )	R		334174		341217
L					334175			
		7/99~4/00	All Incl ABS ( exc. Sport Sus., T4 )	R		334354		341217
L					334355			
	5/00~12/03	All ( exc. Sport Sus., T4, Bad Road Sus. )	R		334438		341145	
L				334439				

CABIN DAMPER "130000" SERIES LISTINGS BY MAKE & OEM No.

"130000" 系列大車件號 (按製造商和 OEM 號碼索引)

製造商	No.	OEM No.
MITSUBISHI FUSO	133011	MC012599
MITSUBISHI FUSO	133011	MC044598
MITSUBISHI FUSO	133011	MC044599
MITSUBISHI FUSO	133011	MC411839
MITSUBISHI FUSO	133011	MK996358
MITSUBISHI FUSO	133011	MK996361
MITSUBISHI FUSO	133017	MC024169
MITSUBISHI FUSO	133020	MC056531
MITSUBISHI FUSO	133024	MC059232
MITSUBISHI FUSO	133019	MK333866
MITSUBISHI FUSO	133020	MK996344
MITSUBISHI FUSO	133019	MK996353
MITSUBISHI FUSO	133024	MK996365
MITSUBISHI FUSO	133032	MK490623
NISSAN DIESEL UD	133005	5610000Z08
NISSAN DIESEL UD	133005	5610000Z74
NISSAN DIESEL UD	136001	56100Z0008
NISSAN DIESEL UD	133005	9524500Z02
NISSAN DIESEL UD	133005	9524500Z65
NISSAN DIESEL UD	133023	9524530Z05
NISSAN DIESEL UD	133007	95245Z0002
HINO	133009	522701021A
HINO	133002	522701030A
HINO	133003	522701161A
HINO	134001	522701220A
HINO	133003	522701260A
HINO	134005	9169129021
HINO	134006	522701430A
HINO	134007	522701420A
ISUZU	133018	1516304800
ISUZU	133021	1516305220
ISUZU	133021	1516305510
ISUZU	133018	1516306070
ISUZU	133021	1516306230



總成避震器全新代名詞  
KYB Strut Plus

一體到位的汽車懸吊解決方案：

品質嚴選：KYB 日系精工避震器搭配專屬彈簧、上座組、緩衝塊與防塵套等 7 項超優質總成配備

安全保固：通過標準耐久測試，並提供產品保固責任，為安全把關

省時省錢：降低安裝時間與失誤，ALL IN ONE 的總成具備絕對價格優勢

KYB Strut Plus 您更換總成避震器的唯一選擇



總代理



永華實業股份有限公司  
YC & Bruder Co., Ltd.  
台北市青島東路 9 號 6 樓之 1  
電話：02-2394-3606  
ycb.com.tw

授權經銷商

信邑國際貿易股份有限公司  
台北市文山區興隆路四段  
165 巷 40 弄 7 號  
電話：02-2938-4004  
scimax.net

匯聖實業有限公司  
新北市中和區中山路二段  
366 巷 10 號 2 樓  
電話：02-8242-1718  
fst-mit.com.tw